

JVC



DVD AUDIO/VIDEO PLAYER

XV-D721BK/XV-D723GD

Introduction	1
Preliminary knowledge	4
Getting started	13
Basic operations	19
Advanced operations	22
Setting and adjustment	40
Additional information	48

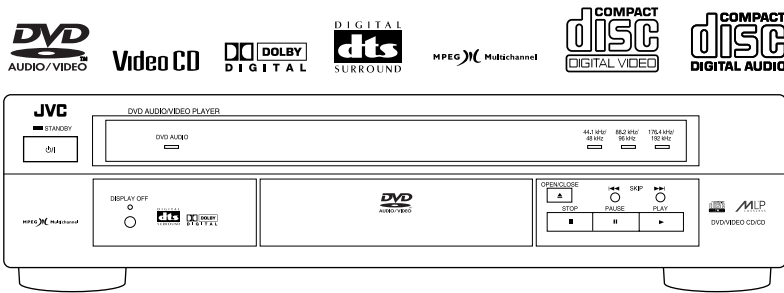
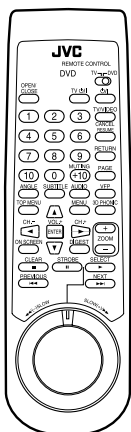

INSTRUCTIONS

For Customer Use:
 Enter below the Model No. and Serial No. which are located on the rear, bottom or side of the cabinet. Retain this information for future reference.

Model No. _____

Serial No. _____

Warnings, Cautions and Others

IMPORTANT for the U.K.

DO NOT cut off the mains plug from this equipment. If the plug fitted is not suitable for the power points in your home or the cable is too short to reach a power point, then obtain an appropriate safety approved extension lead or consult your dealer.

BE SURE to replace the fuse only with an identical approved type, as originally fitted.

If nonetheless the mains plug is cut off ensure to remove the fuse and dispose of the plug immediately, to avoid a possible shock hazard by inadvertent connection to the mains supply.

If this product is not supplied fitted with a mains plug then follow the instructions given below:

IMPORTANT.

DO NOT make any connection to the terminal which is marked with the letter E or by the safety earth symbol or coloured green or green-and-yellow.

The wires in the mains lead on this product are coloured in accordance with the following code:

Blue : Neutral
Brown : Live

As these colours may not correspond with the coloured markings identifying the terminals in your plug proceed as follows:

The wire which is coloured blue must be connected to the terminal which is marked with the letter N or coloured black.

The wire which is coloured brown must be connected to the terminal which is marked with the letter L or coloured red.

IF IN DOUBT - CONSULT A COMPETENT ELECTRICIAN.

Caution —  button!

Disconnect the mains plug to shut the power off completely. The  button in any position do not disconnect the mains line. The power can be remote controlled.

CAUTION

To reduce the risk of electrical shocks, fire, etc.:

1. Do not remove screws, covers or cabinet.
2. Do not expose this appliance to rain or moisture.

Caution: Proper Ventilation

To avoid risk of electric shock and fire and to protect from damage.

Locate the apparatus as follows:

- Front: No obstructions open spacing.
Sides: No obstructions in 3 cm from the sides.
Top: No obstructions in 5 cm from the top.
Back: No obstructions in 15 cm from the back
Bottom: No obstructions, place on the level surface.

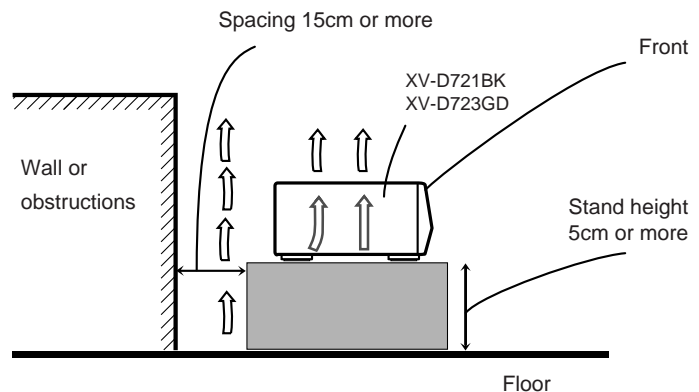

IMPORTANT FOR LASER PRODUCTS

REPRODUCTION OF LABELS

① CLASSIFICATION MARK, PLACED ON REAR ENCLOSURE

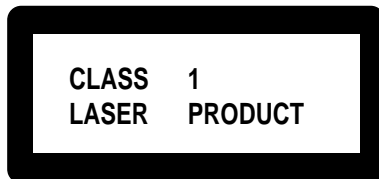

② WARNING LABEL, PLACED INSIDE THE UNIT

CAUTION: Invisible laser radiation when open and interlock failed or defeated. AVOID DIRECT EXPOSURE TO BEAM. (e)

WARNING: Osynlig laserstrålning när denna del är öppnad och spärren är urkopplad. Betrakta ej strålen. (s)

ADVARSEL: Usynlig laserstrålning ved åbning, når sikkerhedsafbrydere er ude af funktion. Undgå udsættelse for stråling. (d)

VARO: Avattaessa ja suo-
jalukitus ohitettaessa olet
alttiina näkymättömälle
lasersäteilylle. Älä katso
säteeseen. (f)

1. CLASS 1 LASER PRODUCT
2. **DANGER:** Visible and invisible laser radiation when open and interlock failed or defeated. Avoid direct exposure to beam.
3. **CAUTION:** Do not open the top cover. There are no user serviceable parts inside the Unit; leave all servicing to qualified service personnel.

Table of contents

Introduction	Page 1	
Features	1	
Supplied accessories	1	
About this instruction manual	2	
Notes on handling	3	
Preliminary knowledge	Page 4	
Names of parts and controls		
Front panel	4	
Remote control unit	5	
Display window	7	
Rear panel	7	
Operational principles		
On-screen displays	8	
To prevent the monitor from burning out [SCREEN SAVER]	11	
On-screen guide icons	11	
How to use numeric buttons	11	
About discs		
Playable disc types	12	
Disc structure	12	
Getting started	Page 13	
Connections		
Before making any connections	13	
To connect to a normal TV	13	
To connect to a TV with the SCART connector	14	
To connect to a stereo audio amplifier or receiver	14	
To connect to an amplifier/receiver equipped with 5.1-channel inputs	15	
To connect to audio equipment with a digital input ..	16	
To connect the power cord	16	
Using the remote control unit		
To install batteries in the remote control unit	17	
To use the remote control unit for TV operation ..	18	
Basic operations	Page 19	
Turning on/off the unit	19	
Inserting and removing discs	19	
Basic playback		
To play a disc from the beginning	20	
To stop playback completely	20	
To stop playback temporarily	20	
To advance or reverse play rapidly while monitoring	20	
To locate the beginning of a scene or song	21	
Resuming playback		
To store the point you want to resume playback from	21	
To resume playback from the stored point	21	
Advanced operations	Page 22	
Playing from a specific position on a disc		
To locate a desired scene from the DVD menu	23	
To locate a desired scene from the menu of the Video CD with PBC	23	
To locate a desired selection using the numeric buttons	24	
To locate a desired chapter or track using ▶▶ or ◀◀	24	
To specify a desired chapter/track from the on-screen display [CHAP. SEARCH/TRACK SEARCH]	25	
		To locate a desired position by specifying the time [TIME SEARCH]..... 25
		To locate a desired scene from the digest display [DIGEST]..... 26
		Special picture playback
		To advance a still picture frame-by-frame..... 27
		To display continuous still pictures [STROBE]..... 27
		To playback in slow-motion [SLOW]..... 28
		To zoom in/out [ZOOM]..... 28
		Changing the track order
		To playback in the desired order [PROGRAM]..... 29
		To playback tracks in random order [RANDOM] .. 30
		Repeat playback
		To repeat a current selection or all tracks [REPEAT]..... 30
		To repeat a desired part [A-B REPEAT]..... 31
		Selecting a scene angle from DVD Video
		To select a scene angle from the normal screen [ANGLE]..... 32
		To select a scene angle from the on-screen display [ANGLE]..... 32
		To select a scene angle from the angle list [ANGLE]..... 33
		Changing the language and sound
		To select the subtitle language [SUBTITLE]..... 33
		To select the audio language or sound [AUDIO] .. 34
		Miscellaneous functions
		To adjust the picture character [VFP]..... 35
		To simulate surround sound [3D PHONIC]..... 36
		To check the disc time [TIME SELECT]..... 37
		To select a still picture on a DVD Audio disc [PAGE]..... 38
		To playback a bonus group of a DVD Audio disc .. 39
		Setting and adjustment
		Page 40
		Selecting preferences
		How to set preferences on the "PREFERENCE" display..... 40
		To set the language and display preference items..... 40
		To set audio and other preference items..... 42
		Speaker setting..... 44
		Limiting playback by children
		To set Parental Lock for the first time [PARENTAL LOCK]..... 46
		To change the settings [PARENTAL LOCK]..... 47
		To temporarily release the Parental lock [PARENTAL LOCK]..... 47
		Additional information
		Page 48
		Care and handling of discs 48
		Troubleshooting 49
		Specifications 50
		Table of languages and their abbreviations Appendix A
		Country code list for parental lock Appendix B

Features

This unit is a compatible player for DVD Audio, DVD Video, Audio CD and Video CD.

Audio features

- Supports audio formats for DVD Audio including high sampling frequencies up to 192 kHz, the linear PCM multichannel format, up to 24-bit resolution and MLP, as well as the audio formats for DVD Video such as Dolby Digital 5.1 ch., MPEG multichannel and DTS.
- The 3D PHONIC system allows you to enjoy virtual surround sound with the conventional 2-channel (stereo) audio system.
- Provides the multichannel (5.1) analog audio outputs, as well as the PCM/Bitstream digital audio outputs.

Video features

- The VFP function allows you to select and adjust the picture character.
- Provides special picture playback functions such as Strobe, Frame-by-frame, Zoom and Slow-motion.

Other features

- Supports various features for DVD Video including Multi-angle, Multi-language Subtitle, Multi-language audio and Parental lock.
- User-friendly on-screen displays allow you to operate the unit easily.

Supplied accessories

- Audio/video cable (x 1)

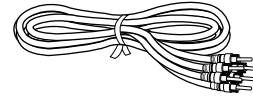

- Audio cables (x 2)



- S-video cable (x 1)

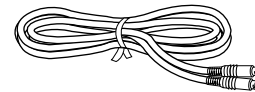

- Remote Control Unit (x 1)

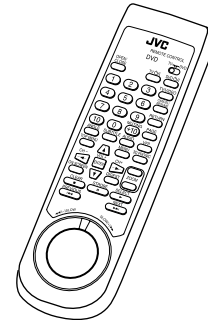

- R03(LR03)/AAA batteries (x 2)

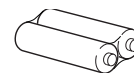

- Instruction manual (x 1)

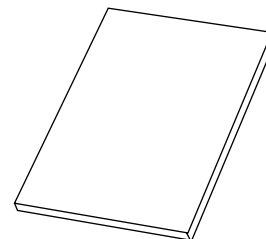

- AC Power Cord (x 1)

Notes on handling

Important cautions

Installation of the unit

- Select a place which is level, dry and neither too hot nor too cold (between 5°C and 35°C, 41°F and 95°F).
- Leave sufficient distance between the unit and the TV.
- Do not use the player in a place subject to vibrations.

Power cord

- Do not handle the power cord with wet hands!
- A small amount of power (1.5 watts) is always consumed while the power cord is connected to the wall outlet.
- When unplugging the player from the wall outlet, always pull the plug, not the power cord.

To prevent malfunction of the unit

- There are no user-serviceable parts inside. If anything goes wrong, unplug the power cord and consult your dealer.
- Do not insert any metallic object into the unit.
- Do not use any non-standard shape disc available on the market, because it may damage the unit.
- Do not use a disc with tape, seals, or paste on it, because damage to the unit may result.

Note about copyright laws

- Please check the copyright laws in your country before recording from discs. Recording of copyrighted material may infringe copyright laws.

Note about the copyguard system

- The DVD Video disc is protected by the copyguard system. When you connect the unit to your VCR directly, the copyguard system activates and the picture may not be played back correctly.

Safety precautions

Avoid moisture, water and dust

Do not place your player in moist or dusty places.

Avoid high temperatures

Do not expose the unit to direct sunlight or place it near a heating device.

When you're away

When away on travel or otherwise for an extended period of time, remove the plug from the wall outlet.

Do not insert foreign objects into the unit

Do not insert wires, hairpins, coins, etc. into the unit.

Do not block the vents

Blocking the vents may damage the unit.

Care of the cabinet

When cleaning the unit, use a soft cloth and follow the relevant instructions on the use of chemically-coated cloths. Do not use benzene, thinner or other organic solvents and disinfectants. These may cause deformation or discoloring.

If water gets inside the unit

Turn off the power switch and remove the plug from the wall outlet, then call the store where you made your purchase. Using the unit in this state may cause a fire or electrical shock.

This product incorporates copyright protection technology that is protected by method claims of certain U.S. patents and other intellectual property rights owned by Macrovision Corporation and other rights owners. Use of this copyright protection technology must be authorized by Macrovision Corporation, and is intended for home and other limited viewing uses only unless otherwise authorized by Macrovision Corporation. Reverse engineering or disassembly is prohibited.

Manufactured under license from Dolby Laboratories. "Dolby", "Pro Logic", "MLP Lossless" and double-D symbol are trademarks of Dolby Laboratories.

Confidential Unpublished Works.

© 1992-1998 Dolby Laboratories, Inc. All rights reserved.

Manufactured under license from Digital Theater Systems, Inc. US Pat. No. 5,451,942 and other world-wide patents issued and pending. "DTS", "DTS Digital Surround", are trademarks of Digital Theater Systems, Inc.

© 1996 Digital Theater Systems, Inc. All rights reserved.

Names of parts and controls

Refer to the corresponding pages indicated in () for details.

Front panel

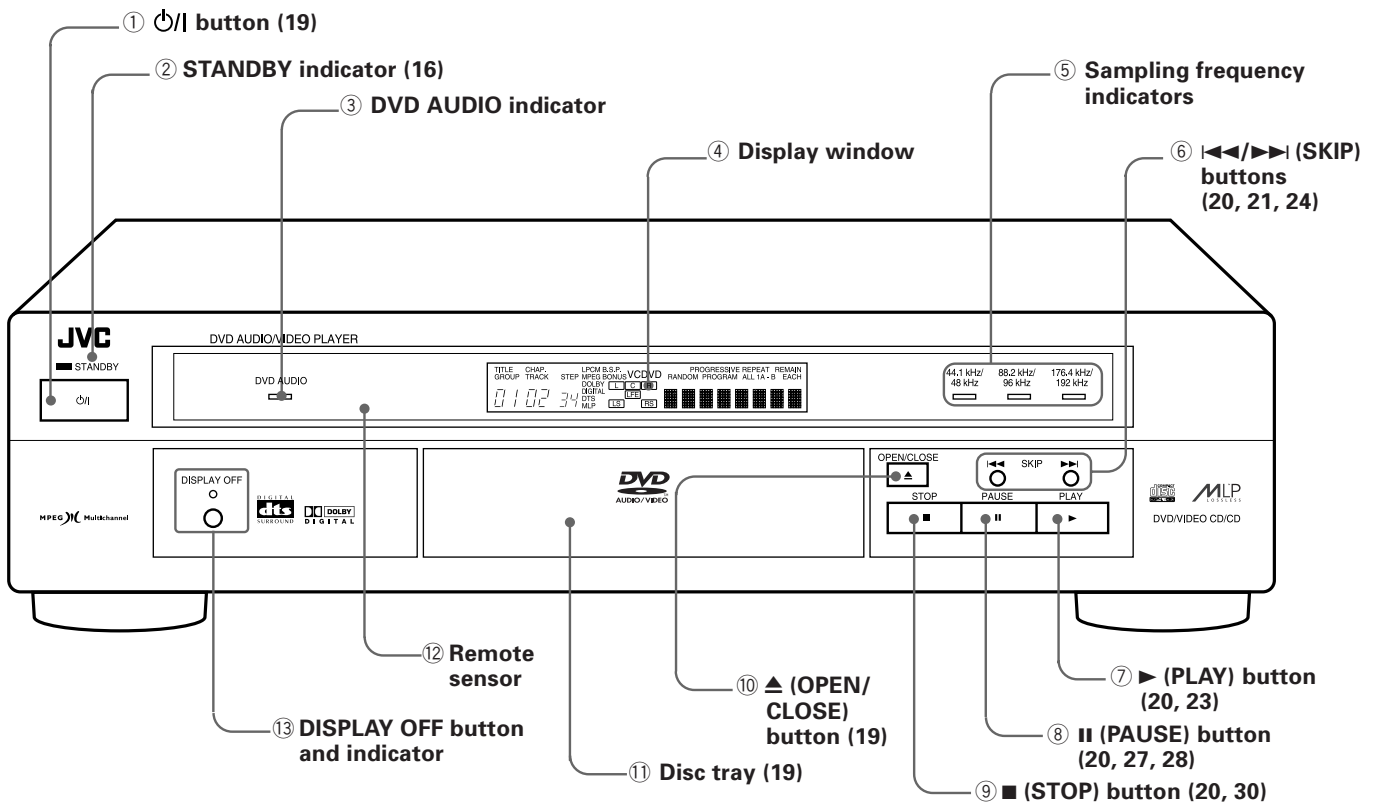

- ① **⏻/⏻ button (19)**
Turns the unit on or off (standby).
- ② **STANDBY indicator (16)**
Lights when the power cord is connected and the unit is on standby. When the unit is turned on, the STANDBY indicator goes off.
- ③ **DVD AUDIO indicator**
Lights when a DVD Audio disc is loaded.
- ④ **Display window**
Indicates the current status of the unit.
- ⑤ **Sampling frequency indicators**
Indicates the sampling frequency currently played back.
- ⑥ **⏮/⏭ (SKIP) buttons (20, 21, 24)**
Pressing the button during playback skips a chapter, title or track.
Holding down the button during playback advances or reverses playback rapidly.
Also used for the page selection of a menu screen for PBC of Video CDs.
- ⑦ **▶ (PLAY) button (20, 23)**
Starts playback. Also used as the SELECT button for PBC of Video CDs.
- ⑧ **⏸ (PAUSE) button (20, 27, 28)**
Pauses playback.
Also, holding down this button displays nine continuous still pictures (STROBE function).
- ⑨ **■ (STOP) button (20, 30)**
Stops playback.
Also used to erase all the programmed tracks for the program play.
- ⑩ **▲ (OPEN/CLOSE) button (19)**
Used to open and close the disc tray.
- ⑪ **Disc tray (19)**
Used to load a disc.
- ⑫ **Remote sensor**
Receives the signal from the remote control unit.
- ⑬ **DISPLAY OFF button and indicator**
The button turns the display window on or off.
When the display window is off, the indicator lights.

Remote control unit

Preliminary knowledge

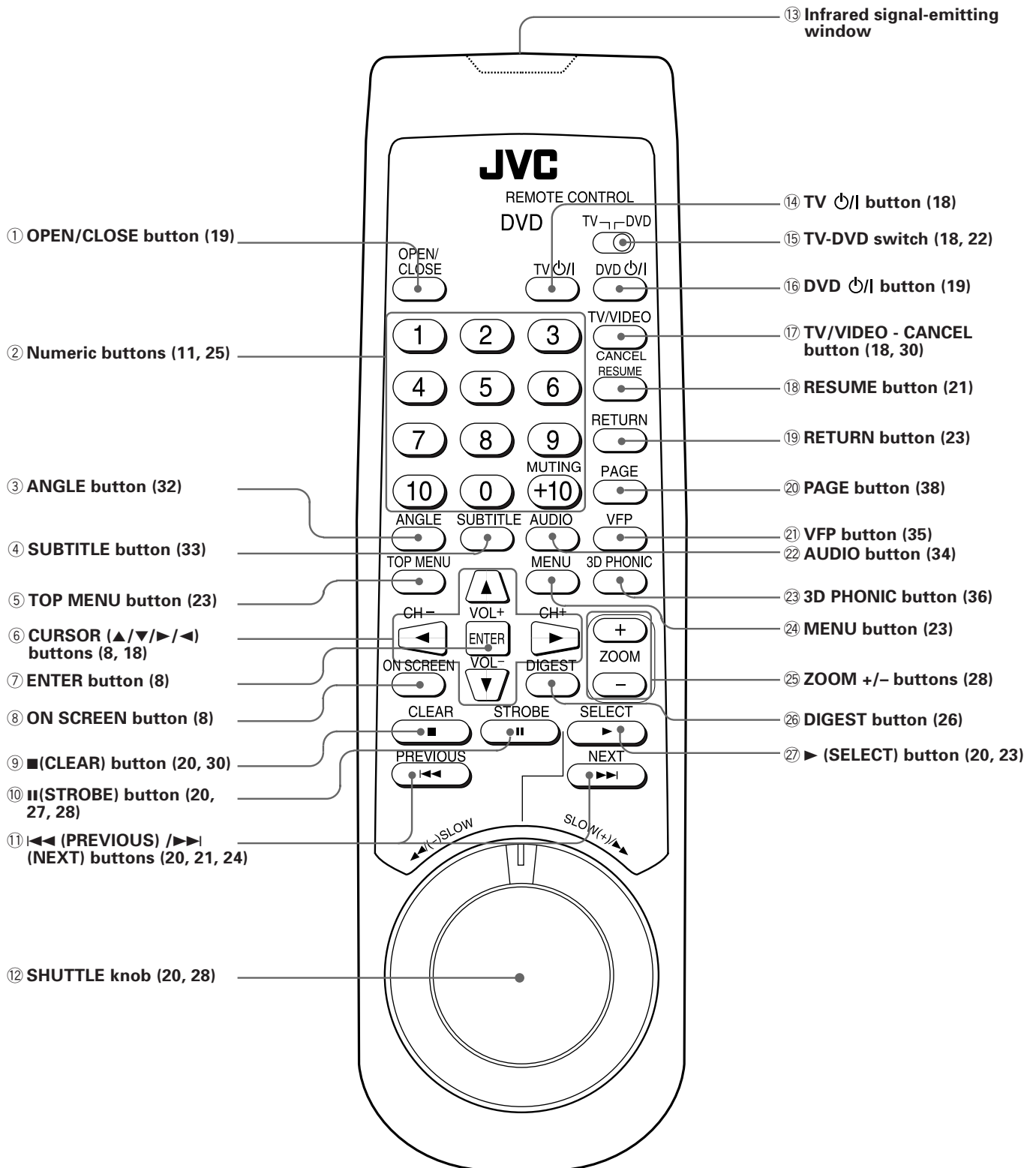

- ① **OPEN/CLOSE button (19)**
Opens and closes the disc tray.
- ② **Numeric buttons (11, 25)**
Mainly used to select a title/track number or a TV channel. Also used to enter a time for the Time search and a chapter number for the Chapter search.
- ③ **ANGLE button (32)**
Changes camera angles during playback of a DVD Video disc containing multiple camera angles.
- ④ **SUBTITLE button (33)**
Turns on or off a DVD subtitle.
- ⑤ **TOP MENU button (23)**
Displays the top menu of a DVD Audio disc or the title menu of a DVD Video disc on the TV screen.
- ⑥ **CURSOR (◀/▶/▲/▼) buttons (8, 18)**
Used to select an item from a menu or on-screen display, or to change the setting of an item in the on-screen display.
Also, the ▲/▼ buttons are used to adjust the TV volume, while ▶/◀ are used to change the TV channel.
- ⑦ **ENTER button (8)**
Executes the selected item in a menu or on-screen display.
- ⑧ **ON SCREEN button (8)**
Displays an on-screen display of the unit on the TV screen.
- ⑨ **■ (CLEAR) button (20, 30)**
Stops playback.
Also used to erase all the programmed tracks for the program play.
- ⑩ **⏸ (STROBE) button (20, 27, 28)**
Pauses playback.
Also, holding down this button displays nine continuous still pictures (STROBE function).
- ⑪ **⏮ (PREVIOUS) / ⏭ (NEXT) buttons (20, 21, 24)**
Pressing the button during playback skips a chapter, title or track.
Holding down the button during playback advances or reverses playback rapidly.
Also used for the page selection of a menu screen for PBC of Video CDs.
- ⑫ **SHUTTLE knob (20, 28)**
Performs rapid advance/reverse playback operations.
Also used for slow-motion playback of a picture (for DVD Video/Video CD)
- ⑬ **Infrared signal-emitting window**
Point this window toward the remote sensor on the front panel when pressing buttons.
- ⑭ **TV ⏻/⏻ button (18)**
Turns the TV on or off.
- ⑮ **TV-DVD switch (18, 22)**
Selects the functions of the numeric, cursor and TV/VIDEO - CANCEL buttons to control the corresponding device.
- ⑯ **DVD ⏻/⏻ button (19)**
Turns the unit on or off (standby).
- ⑰ **TV/VIDEO - CANCEL button (18, 30)**
Switches the TV input mode when the TV-DVD switch is set to TV.
Cancels the last selection of the program when the TV-DVD switch is set to DVD.
- ⑱ **RESUME button (21)**
Used to resume playback from the point you interrupted playback last time.
- ⑲ **RETURN button (23)**
Returns to the previous menu (for DVD Audio/DVD Video/Video CD).
- ⑳ **PAGE button (38)**
Turns the page of B.S.P. (still picture) for a DVD Audio disc.
- ㉑ **VFP button (35)**
Used to adjust the picture character.
- ㉒ **AUDIO button (34)**
Selects the audio (for DVD Video/DVD Audio/Video CD).
- ㉓ **3D PHONIC button (36)**
Produces a simulated surround effect.
- ㉔ **MENU button (23)**
Displays a DVD menu on the TV screen.
- ㉕ **ZOOM +/- buttons (28)**
Zooms in or out the picture (for DVD Video/Video CD).
- ㉖ **DIGEST button (26)**
Displays beginning scenes of each title, chapter or track on the TV screen (for DVD Video/Video CD).
- ㉗ **▶ (SELECT) button (20, 23)**
Starts playback. Also used as the SELECT button for PBC of Video CD discs.

Display window

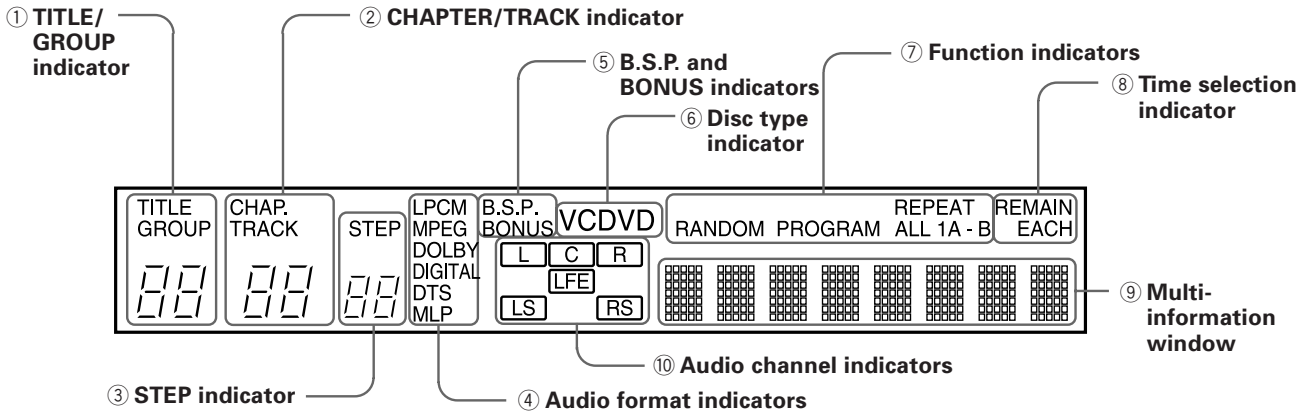

- ① **TITLE/GROUP indicator**
Displays the current title/group number.
- ② **CHAPTER/TRACK indicator**
Displays the current chapter/track number.
- ③ **STEP indicator**
Displays the current step number of the program.
- ④ **Audio format indicators**
Indicates the format of audio currently being played back.
- ⑤ **B.S.P. and BONUS indicators**
When the current DVD Audio disc contains B.S.P. (browsable still picture), "B.S.P." lights. When the current DVD Audio disc contains a BONUS group, "BONUS" lights.
- ⑥ **Disc type indicator**
Indicates the type of the disc loaded. "DVD" lights when a DVD Audio or DVD Video disc is loaded, "CD" lights when an Audio CD is loaded, and "VCD" lights when a Video CD is loaded.
- ⑦ **Function indicators**
Each indicator lights when the corresponding function is active.
- ⑧ **Time selection indicator**
Shows the time mode indicated in the Multi-information window.
- ⑨ **Multi-information window**
Displays time and status information.
- ⑩ **Audio channel indicators**
Indicates audio channels currently being played back.

Rear panel

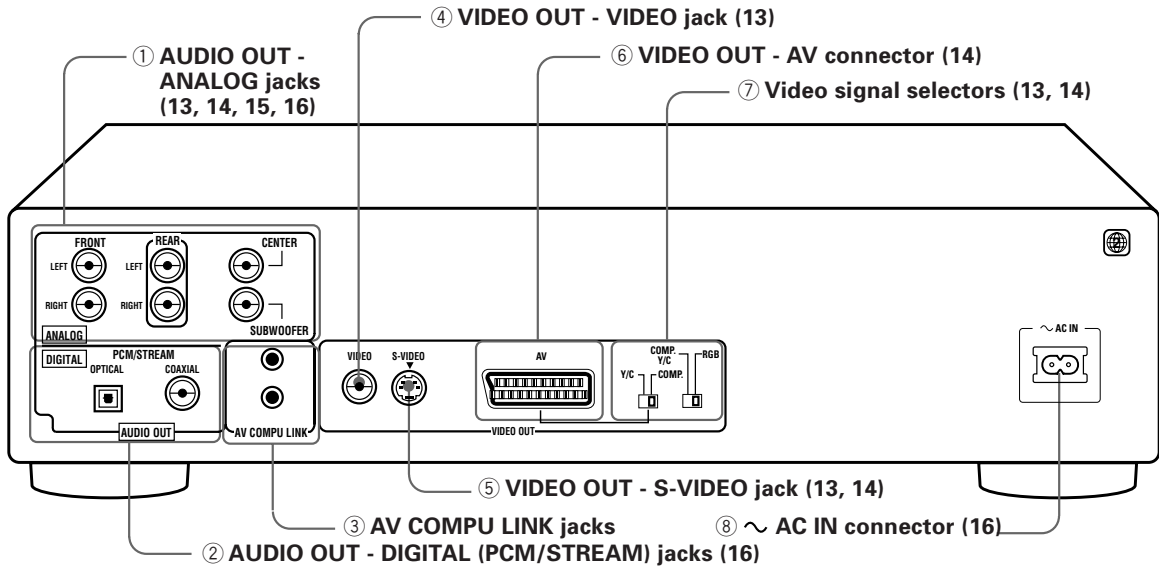

- ① **AUDIO OUT - ANALOG jacks (13, 14, 15, 16)**
Outputs the multichannel signals of a DVD Audio disc recorded by the linear PCM multichannel format or a DVD Video disc recorded by the Dolby Digital surround, DTS or MPEG multichannel format. FRONT jacks also output stereo analog audio signals.
- ② **AUDIO OUT - DIGITAL (PCM/STREAM) jacks (16)**
Output digital audio signals. Both coaxial and optical connectors are provided.
- ③ **AV COMPU LINK jacks**
These jacks are provided for use in the future. They are currently not used.
- ④ **VIDEO OUT - VIDEO jack (13)**
Outputs a composite video signal.
- ⑤ **VIDEO OUT - S-VIDEO jack (13, 14)**
Outputs an S-video signal.
- ⑥ **VIDEO OUT - AV connector (14)**
The standard 21-pin SCART connector outputs the video and audio signals. You can select the video signal type by the selectors on the right.
- ⑦ **Video signal selectors (13, 14)**
You can select the type of the video signal fed from the AV connector using these selectors. To select the RGB signal, set the right-hand (COMP. Y/C - RGB) selector to "RGB". To select the composite signal, set the right-hand selector to "COMP. Y/C" and the left-hand (Y/C - COMP.) selector to "COMP". To select Y/C, set the right-hand selector to "COMP. Y/C" and the left-hand selector to "Y/C."
- ⑧ **~ AC IN connector (16)**
Connects to the wall outlet using the supplied AC power cord.

Operational principles

On-screen displays

The unit provides several on-screen displays as shown below for choosing preferences for initial settings and functions which are not frequently used.

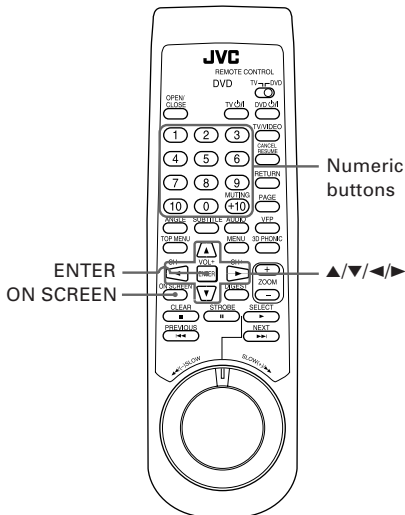

To bring up on-screen displays

Press ON SCREEN. (Note that the operation for bringing up the "PARENTAL LOCK" on-screen display is different.) Depending on the type of disc inserted (or "no disc") and the unit's mode, the proper on-screen display appears.

Basic operations in on-screen displays

- You can move using the CURSOR / / / buttons to select items you want to work with.
- With an item like , you can change the setting by using CURSOR / buttons when is on the item.
- - type item works when you place on the item and press ENTER.
- In the message box, the operation to be performed is displayed according to the item pointed by .
- Numbers are entered using the numeric buttons.
- Some functions become effective by pressing ENTER after specifying necessary entries.
- Pressing ON SCREEN again turns off the on-screen display.

Preliminary knowledge



Opening display

An opening display appears automatically (without pressing the ON SCREEN button) in some conditions.

The display shown on the left appears when the unit turns on with no disc inserted.

One of the similar displays shown below appears when a corresponding disc is set and stopped. For an Audio CD or DVD Audio disc that does not contain any picture, the opening display does not disappear after starting playback.

for DVD Audio

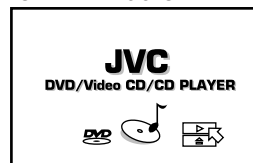

for DVD Video



for Audio CD

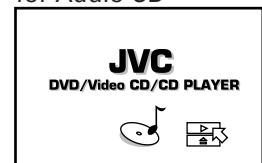

for Video CD



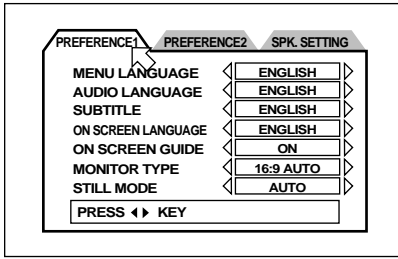

PREFERENCE (1, 2) and SPK. SETTING (Speaker setting) displays (see page 40)

You can set preferences and speaker settings via these displays.

To bring up the PREFERENCE 1 / PREFERENCE 2 / SPK. SETTING display

- 1 When a DVD Video disc is set and stopped or no disc is inserted, press ON SCREEN.
- 2 To select the display, move to the desired tab using the CURSOR <=> buttons.

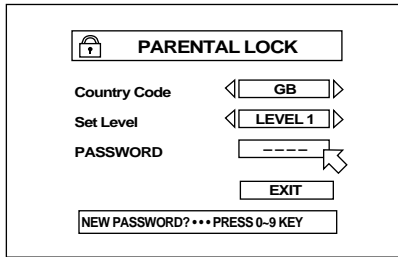
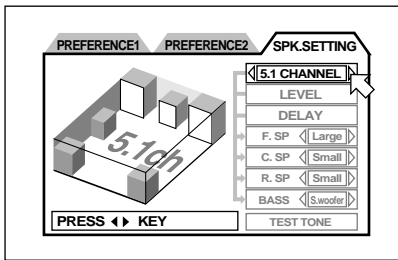
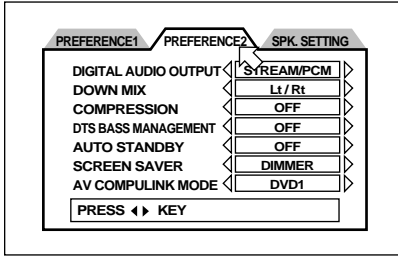

PARENTAL LOCK display (see page 46)

You can set the parental lock from this display.

To bring up the PARENTAL LOCK display

When no disc is inserted or a DVD Video disc is stopped, press ENTER while holding down .

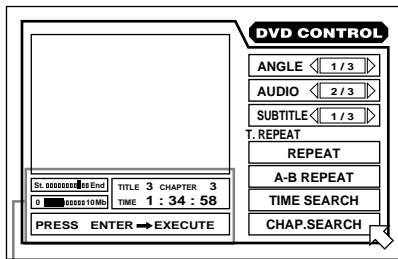

DVD VIDEO CONTROL display

You can select and set various functions for DVD Video playback from this display.

This display appears only during DVD Video playback.

To bring up the DVD VIDEO CONTROL display

During DVD Video playback, press ON SCREEN.

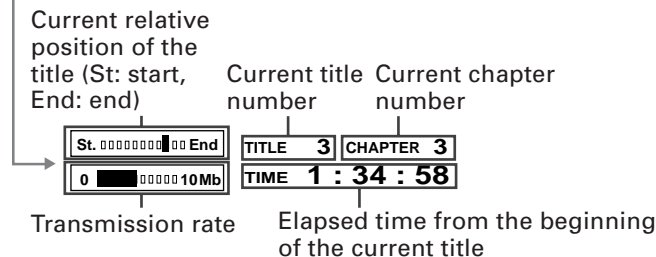

(during playback of pictures together with audio)

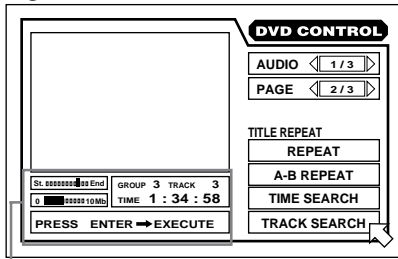

Current relative position of the title (St: start, Current group Current track End: end) number number



Transmission rate Elapsed time from the beginning of the current title

DVD AUDIO CONTROL display

You can select and set various functions for DVD Audio playback from the display.

There are two types of DVD AUDIO CONTROL display. One is shown during playback of pictures together with audio, while the other is shown during playback of audio only or while stopped.

To bring up the DVD AUDIO CONTROL display

Press ON SCREEN when a DVD Audio is inserted. One of the displays above appears according to the disc contents and the unit's status.

(during playback audio only or while stopped)

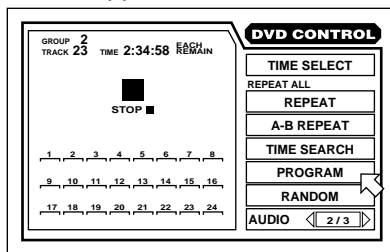

CD CONTROL display

You can select and set various functions for Audio CD playback from this display.

To bring up the CD CONTROL display

Whenever an Audio CD is inserted, press ON SCREEN.

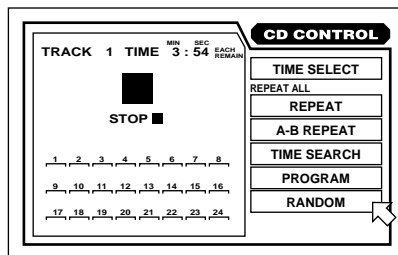

VCD CONTROL display

There are two types of VCD CONTROL display. The display shown on the left appears only during Video CD playback.

When a Video CD disc is stopped, a display similar to the CD CONTROL display shown above appears.

To bring up the VCD CONTROL display

Press ON SCREEN when a Video CD is inserted. The appropriate display appears according to the unit's status.

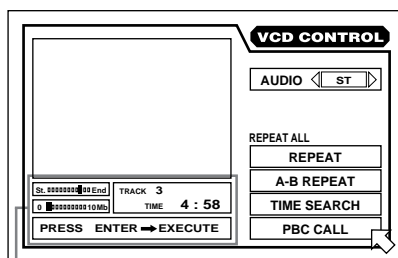

Current relative position of the track (St: start, End: end) Current track number



Transmission rate Elapsed time from the beginning of the current track

To prevent the monitor from burning out [SCREEN SAVER]

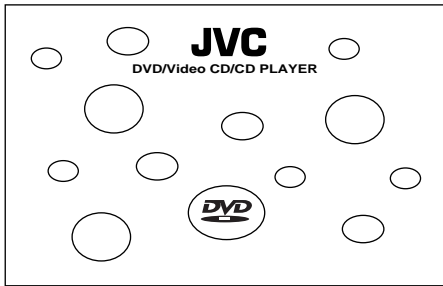

A television monitor screen may be burned out if a static picture is displayed for a long time. To prevent this, the unit automatically activates the screen saver function if a static picture, such as an on-screen display or menu, is displayed for over several minutes.

- Pressing any button on the unit or the remote control unit will release the screen saver function and return to the previous display.
- You can select one of several screen saver modes available (see page 43).

On-screen guide icons

During DVD playback, you may see icons displayed over the picture. These have the following meanings.



: Displayed at the beginning of a scene recorded from multiple angles. (See page 32.)





: Displayed at the beginning of a scene recorded with multiple audio languages. (See page 34.)



: Displayed at the beginning of a scene recorded with multiple subtitle languages. (See page 33.)

You can set the unit not to display on-screen icons above via the preference settings described on page 41.

About invalid operation icon

When you press a button, if the unit does not accept its operation,  appears on your television screen. Operations are occasionally unacceptable even if  is not displayed.

Note that some operations may not be accepted. For example, some discs may not allow rapid advance/reverse or slow-motion playback.

How to use numeric buttons

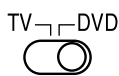

The function of the numeric buttons differs depending on the setting of the TV-DVD switch. When setting it to TV, the buttons are used to select a TV channel. When setting it to DVD, the buttons are used to select a track/title/group or enter a disc time or chapter number.

To select a track/title/group number

- **To select a number between 1 and 10**
Press the corresponding button for the number.
- **To select a number higher than 10**
Use the +10 button.

Examples:

To select 13 +10 → 3

To select 34 +10 → +10 → +10 → 4

To select 40 +10 → +10 → +10 → 10

To enter a time or chapter number

The method for entering a time for Time search or chapter number for Chapter search is different from above. See the corresponding sections in this manual for the details.

To select a TV channel

Press the corresponding numeric buttons. See page 18 for details.

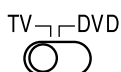

About discs

Playable disc types

Playable and non-playable disc types are as follows:

Playable discs

DVD audio 	DVD video 	Video CD 	Audio CD 
--	--	---	--

- DVD Video players and DVD Video discs have their own Region Code numbers. This unit only can playback DVD Video discs whose Region Code numbers include "2".

Examples of playable DVD Video discs:



Non-playable discs

DVD-ROM, DVD-RAM, DVD-R, DVD-RW, CD-ROM, PHOTO CD, CD-EXTRA, CD-G, CD-TEXT, CD-R, CD-RW

- Playing back discs listed as "Non-playable discs" in the table above may generate noise and damage speakers.
- This unit can playback audio recorded in CD-G, CD-EXTRA and CD-TEXT discs.

Disc structure

A DVD Video disc is comprised of "titles" and each title may be divided into some "chapters." For example, if a DVD Video disc contains some movies, each movie may have its own title number, and each movie may be divided into some chapters. In a DVD Video karaoke disc, each song usually has its own title number and does not have chapters. A DVD Audio disc is comprised of "groups", and each group is comprised of "tracks." Some DVD Audio discs also contain a "bonus group" that can be played back by entering the password. Usually the contents of a "bonus group" are not opened to the public. Note that most DVD Audio discs include other information in addition to audio, such as still pictures, movies and text. An Audio CD or Video CD is simply comprised of "tracks."

(Example: DVD Video disc)

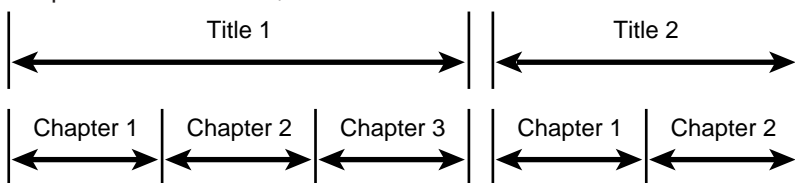

(Example: DVD Audio disc)

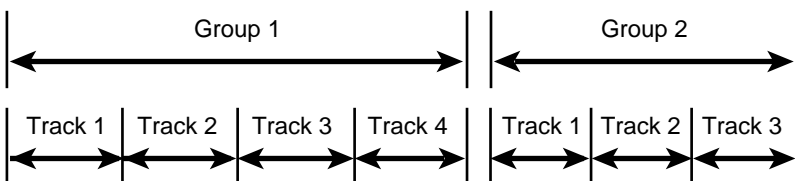

(Example: Audio CD/Video CD)

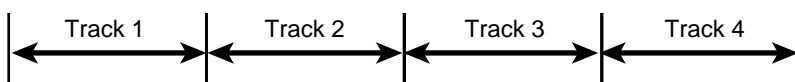

Connections

*In the following description, "TV" may be substituted with "monitor" or "projector."

*Before using the unit, you have to connect the unit to a TV and/or amplifier.

Before making any connections

- Do not connect the AC power cord until all other connections have been made.
- Since different components often have different terminal names, carefully read the instructions supplied with the component you are going to connect.

To connect to a normal TV

You can enjoy using the unit by simply connecting it to a TV. To improve audio sound quality, connect the audio outputs to your separate audio equipment. (See the following pages.)

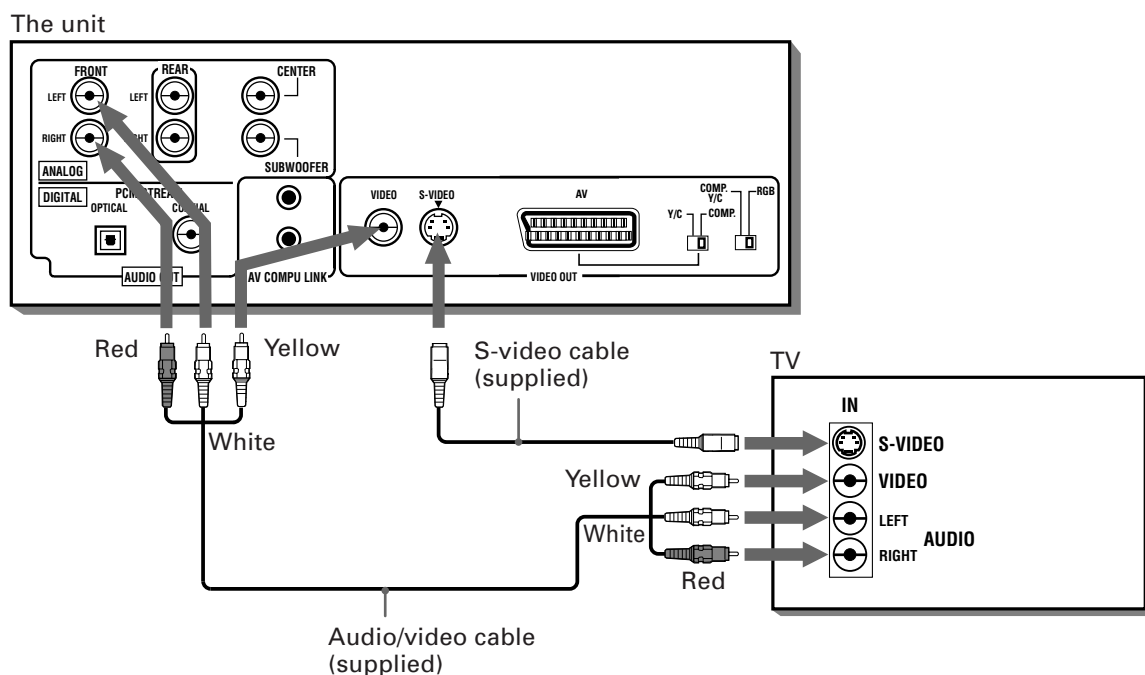

Connect the unit to a TV equipped with stereo audio input and video input jacks using the supplied audio/video cables.

- If your TV has a monaural audio input instead of stereo, you need to use an optional audio cable which converts stereo audio output to monaural.
- If your TV has an S-video input, you should connect it with the S-VIDEO output of the unit using the supplied S-video cable in addition to the (standard) video connection to get better picture quality.

NOTES

- Connect the unit to a PAL television or multi-scan television.
- When making the audio connection using the FRONT (LEFT and RIGHT) jacks, set "DOWN MIX" in "PREFERENCE 2" to "Lo/Ro" and the Speaker setting in "SPK. SETTING" to "2 CHANNNEL". See pages 42 and 44.
- Connect VIDEO OUT of the unit directly to the video input of your TV. Connecting VIDEO OUT of the unit to a TV via a VCR may cause a monitor problem when playing back a copy-protected disc.

To connect to a TV with the SCART connector

You can enjoy using the unit by simply connecting it to your television set with a 21-pin SCART cable. To hear audio sound with better quality, connect the audio output to your audio equipment.

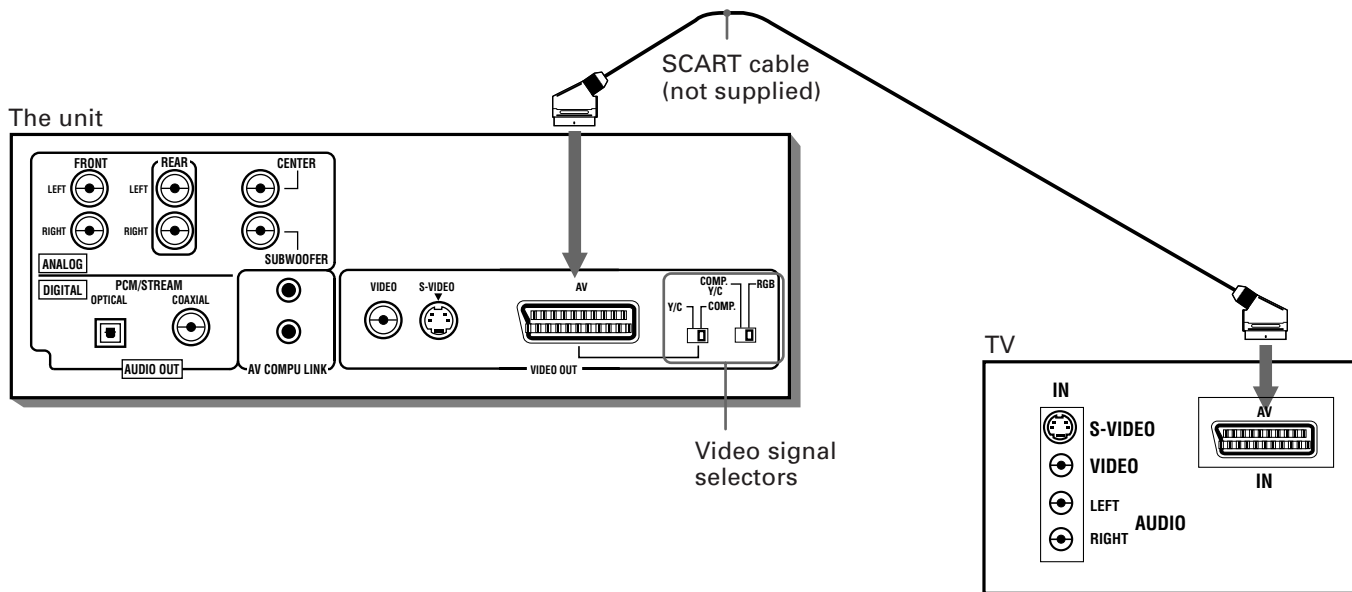

Connect the unit's AV OUT connector with your TV's SCART connector using an optional SCART cable.

- Set the video signal selectors correctly according to your TV.
If the TV only accommodates the composite video signal, set the right-hand selector to "COMP. Y/C" and the left-hand selector to "COMP".
If the TV accommodates the RGB signal, set the right-hand selector to "RGB".
If the TV accommodates the Y/C signal, set the right-hand selector to "COMP. Y/C" and the left-hand selector to "Y/C."

NOTES

- Connect the unit to a PAL television or multi-scan television.
- When setting the video signal selection to "RGB", no signal is output from the VIDEO and S-VIDEO jacks.
- When using the SCART connector, make the "DOWN MIX" setting in "PREFERENCE 2" to "Lo/Ro" and the Speaker setting in "SPK. SETTING" to "2 CHANNEL" (see pages 42 and 44).

To connect to a stereo audio amplifier or receiver

You can enjoy high-quality stereo audio by connecting the unit's audio output to your stereo amplifier or receiver.

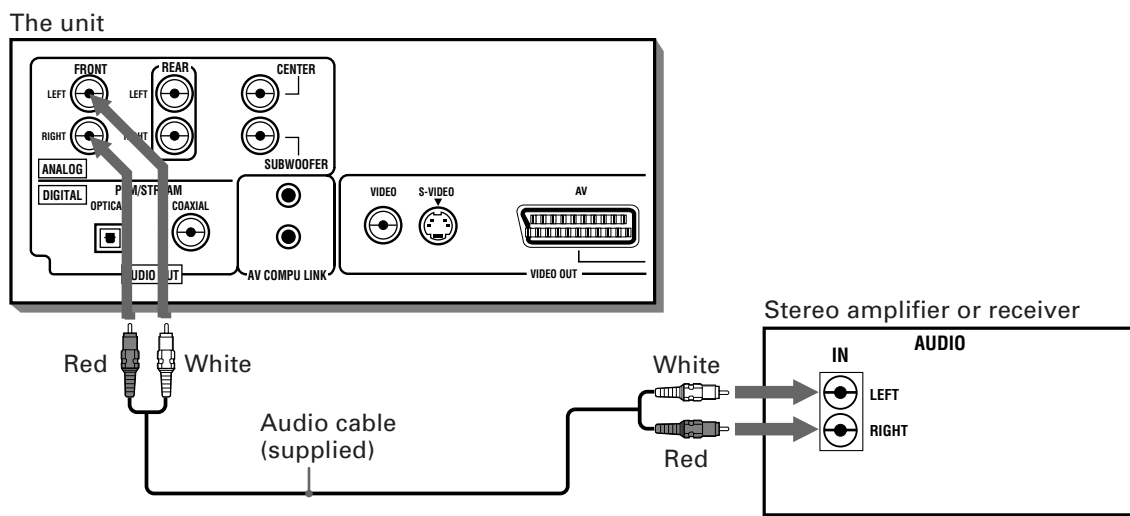

- Connect the unit's ANALOG FRONT LEFT/RIGHT outputs to any line-level inputs (such as AUX, DVD, CD, etc.) of a stereo audio amplifier or receiver.

NOTE

- When using the unit with a stereo amplifier or receiver, make the "DOWN MIX" setting in "PREFERENCE 2" to "Lo/Ro" and the Speaker setting in "SPK. SETTING" to "2 CHANNEL" (see pages 42 and 44).

To connect to an amplifier/receiver equipped with 5.1-channel inputs

The unit supports the linear PCM multichannel format of DVD Audio and can feed multichannel audio output signals from the 6 ANALOG AUDIO OUT jacks.

It is also equipped with the DTS and Dolby digital decoders. So you can enjoy any type of the high quality surround sounds by connecting the unit to an amplifier/receiver equipped with the 5.1-channel inputs.

Connect the unit's ANALOG AUDIO OUT jacks to the analog 5.1-channel inputs of an amplifier or receiver using the supplied audio cables.

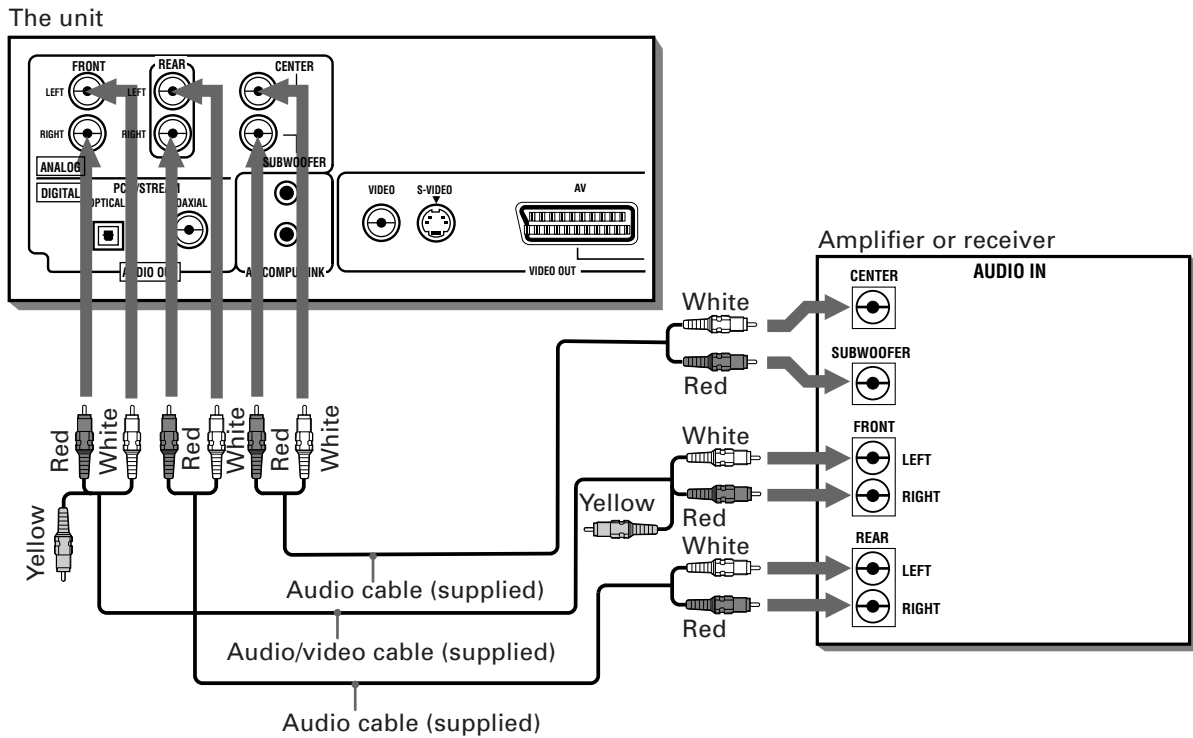

- Be sure to connect correctly between corresponding terminals. The order of the 5.1-channel terminals depend on units.

NOTE

- When using the 5.1-channel outputs of the unit, set the "DOWN MIX" in the "PREFERENCE 2" on-screen display to "OFF" and select "5.1 CHANNEL" or "EXPERT" in the "SPK.SETTING" on-screen display. If the "EXPERT" is selected, you can control the audio output balance of the speakers (see pages 42 and 44).

To connect to an audio equipment with a digital input

You can enhance the sound quality by connecting the unit's DIGITAL output (OPTICAL or COAXIAL) to the digital input of an amplifier, DAT or MD by using an optional digital cable. The digital audio signal from a disc is directly transferred. If you connect the unit to a Dolby Digital, DTS or MPEG Multichannel decoder or an amplifier with a built-in decoder by using an optional digital cable, you can enjoy high-quality surround sound.

When you make the digital connection, also make the analog connection, because, depending on the disc type, no audio may be reproduced from the DIGITAL outputs.

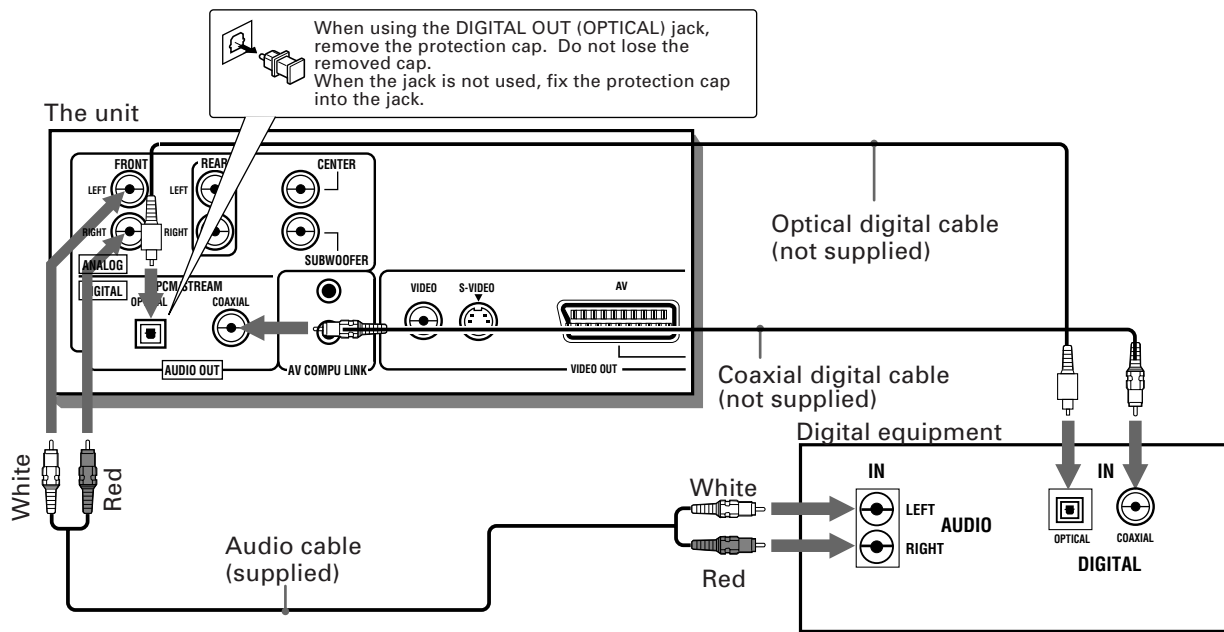

- For digital connection, connect the unit's DIGITAL output (OPTICAL or COAXIAL) to the digital input of an audio equipment using an optional digital cable.

NOTES

- When you connect the unit's DIGITAL output to a digital audio equipment, before using, make the "DIGITAL AUDIO OUTPUT" setting in the "PREFERENCE 2" on-screen display correctly according to the connected audio equipment. If the "DIGITAL AUDIO OUTPUT" is not set correctly, loud noise may be generated from speakers, causing damage to your speakers. See "DIGITAL AUDIO OUTPUT" on page 42.
- When you connect the unit's DIGITAL output to a Dolby Digital, DTS or MPEG Multichannel decoder (or amplifier with a built-in decoder) to enjoy surround sound, the unit's "COMPRESSION" setting in the "PREFERENCE 2" on-screen display and all settings in the "SPK. SETTINGS" display are invalid. Make appropriate surround audio settings by the decoder.

To connect the power cord

When all the audio/video connections have been made, insert the smaller plug of the supplied AC power cord to the unit's ~ AC IN connector, then insert the other end to the wall outlet. Make sure that plugs are inserted firmly. The STANDBY indicator lights and setup is completed.

Warning

- Disconnect the power cord if you are not going to use the unit for a long time.
- Disconnect the power cord before cleaning the unit.
- Disconnect the power cord before moving the unit.
- Do not connect or disconnect the power cord with wet hands.
- Do not pull the power cord when disconnecting it, as this may damage the cord and cause fire, electric shock, or other accidents.

Caution

- Do not damage, alter, twist, or pull the power cord, as this may cause fire, electric shock, or other accidents.
- To prevent any accidents or damages caused by an unsuitable AC power cord, only use the supplied power cord. If the cord is damaged, contact a dealer and get the new power cord.
- Do not put anything heavy, or the unit, on the power cord, as this may cause fire, electric shock, or other accidents.

Using the remote control unit

Using the remote control, you can operate not only all the functions of the unit but also basic functions of your TV.

To install batteries in the remote control unit

The battery compartment is located on the back of the remote control unit.

- 1 Press down the point shown by the arrow at the side of the compartment cover and pull it up to open the cover.



- 2 Place the two accessory R03 (LR03/AAA) batteries in the remote control according to the polarity markings (“+” and “-”) inside the compartment and on the batteries.

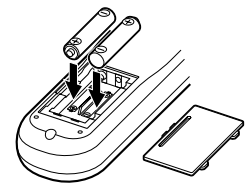

- 3 Place the cover over the compartment, and press down lightly.



- The batteries will last about six months with normal use. If the functions of the remote control become erratic, replace the batteries. See below for more information.

Precautions for the safe use of batteries

Observe the following precautions for the safe use of batteries. If they are used improperly their life will be shortened, they may burst or their contents may leak.

Precaution

- Remove the batteries from the remote control if it is not going to be used for a long period of time.
- Remove dead batteries and dispose of them properly.
- Never leave dead batteries lying around, take them apart, mix them with other refuse, or throw them into an incinerator.
- Never touch liquid that has leaked out of a battery.
- Do not mix new and old batteries, or batteries of different types, when replacing them.

To use the remote control unit for TV operation

You can operate your TV from the remote control unit.

Setting the remote control signal for operating your TV.

- 1 Holding down TV/VIDEO, enter the manufacturer code of your TV listed below by using the numeric buttons (0 - 9).
Do not release TV/VIDEO. Keep holding it until the next step is completed.

Example:

To enter the manufacturer code "01":
Press "0" then "1."

Manufacturer code list

No.	Manufacturer
01	JVC
02	PHILIPS/CCE/MAGNAVOX
03	MITSUBISHI
04	PANASONIC
05	RCA
06	SHARP
07	SONY
08	TOSHIBA
09	ZENITH
10	PHILCO/HITACHI
11	PANASONIC
12	SAMSUNG
13	SANYO/SEARS
14	TOSHIBA
15	GRADIENTE
16	SANYO
17	PHILCO/DAEWOO
18	LG (GOLDSTAR)
19	GRUNDIG
20	NEC/GRADIENTE
21	PHILCO

No.	Manufacturer
22	BEIJING/NOBLEX
23	JVC (ONWA)
24	JVC (ONWA)
25	JVC (ONWA)
26	THOMSON
27	FERGUSON
28	ITT
29	MIVAR
30	FINLUX
31	NOKIA
32	FUNAI
33	SAMSUNG
34	SAMSUNG/PEONY/CHANGHONG
35	SAMSUNG
36	AIWA
37	DEAWOO
38	JINXING/PEONY
39	PEONY
40	KONKA
41	TCL

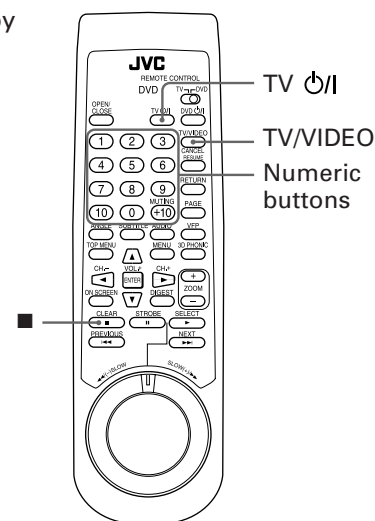

- 2 Press ■ while holding down TV/VIDEO.
- 3 Try to operate your TV by pressing TV ϕ /I.
If your TV turns on or off, you have successfully set the control signal.

The following buttons can be used for operating the TV.

To use the CURSOR (CH.-, CH.+, VOL.+, VOL.-), TV/VIDEO and numeric buttons for TV control, set the TV-DVD switch to "TV".

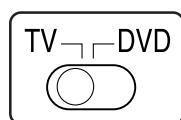

	Turns the TV on or off.
	Used to change the TV channel.
	Used to adjust the TV volume.
	Used to select the TV channel.
	Mutes the TV sound.
	Switches input mode (either TV or VIDEO). Used to switch the TV input mode between TV and VIDEO.

NOTES

- The remote control unit is initially set for operating a JVC TV.
- If there is more than one code listed for the manufacturer of your TV, try them one by one until you succeed.

Basic operations

In the following description, the buttons on the remote control unit are mainly used, however, you may use the corresponding buttons on the front panel of the unit if available.

Turning on/off the unit

Press O/I on the front panel or DVD O/I on the remote control unit.

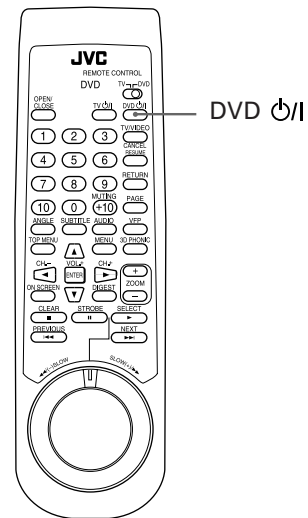
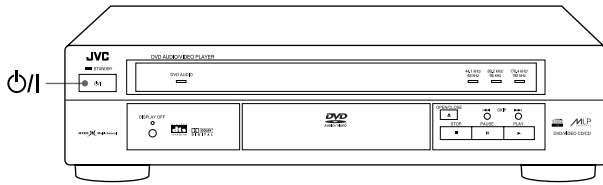

Hints

- You can turn on the unit by pressing the \blacktriangleright button on the front panel or the remote control unit. In this operation, the unit starts playback when the disc is set.
- You can also turn on the unit by pressing the OPEN/CLOSE button on the front panel or the remote control unit. In this case, the disc tray opens.

NOTE

- Even if you press the O/I or DVD O/I button to turn off the unit, the unit is not disconnected from the AC power source as long as it is connected to the wall outlet. This state is called the standby mode. In this state, the unit consumes a very small amount of power.

Inserting and removing discs

- 1 Press OPEN/CLOSE to open the disc tray.
- 2 Place the disc in the tray.

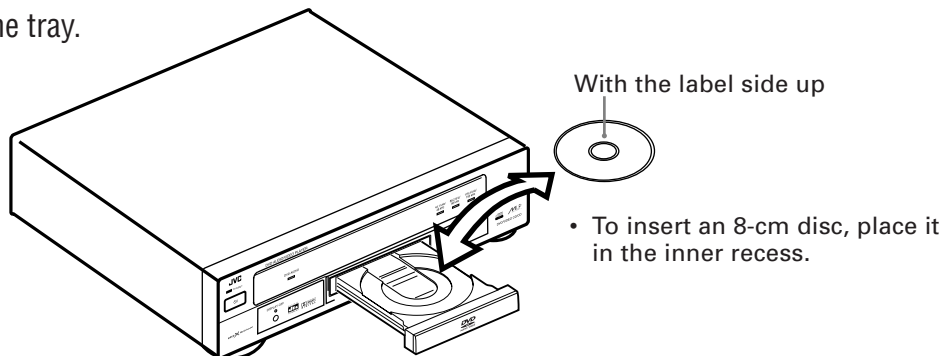

- 3 Press OPEN/CLOSE to close the disc tray.

The unit reads the disc information and the corresponding opening display (depending on the disc type) appears on the TV screen.

Hints

You can also open and close the disc tray from the opening display.

Use CURSOR $\blacktriangle/\blacktriangledown$ to move \leftarrow to O/I , then press ENTER to open or close the disc tray.

NOTES

- With some DVD Video discs, the unit starts playback automatically after inserting the disc.
- The unit can playback DVD Audio, DVD Video, Audio CD, and Video CD discs only. Do not load other disc types. For details about playable disc types, see page 12.
- If you insert a DVD Video disc whose region code does not match the unit, "REGION CODE ERROR!" is shown in the DVD opening display. For detail about the region code, see page 12.
- When loading a disc in the tray, be sure to position the disc inside the recess. Otherwise, the disc may be damaged when the tray is closed or the disc may not be removed from the unit.
- Do not use any stabilizer when playing back a disc.

Basic playback

Now you can play a disc. First, let's enjoy simple playback according to following procedure.

To play a disc from the beginning



Press ►.

The unit starts playback from the beginning.

NOTES

- With Video CD discs with PBC control or some DVD discs, the menu display may appear on the TV screen after pressing ►. In such a case, select an item to be played back from the menu.
For operation using a menu, see page 23.
- With some DVD Video discs, the unit starts playback automatically after inserting the disc.

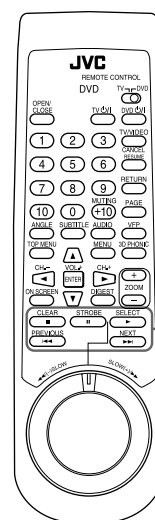

Basic control buttons

To stop playback completely



Press ■.

The unit stops playback.

To stop playback temporarily



Press ⏸.

The unit pauses playback. To continue playback, press ►.

To advance or reverse playback rapidly while monitoring



■ During playback

Method 1

Use the SHUTTLE knob on the remote control unit.

To advance playback rapidly, turn the shuttle knob to the right and hold, and to reverse play rapidly, turn the shuttle knob to the left and hold. When you release the shuttle knob, the unit returns to normal playback. The playback speed changes according to the amount you turn the shuttle knob.

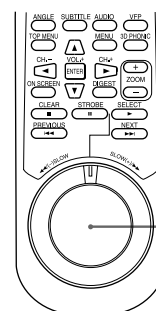

SHUTTLE knob

Method 2

Hold down ◀◀ or ▶▶.

Holding down ▶▶ advances playback rapidly, while holding down ◀◀ reverses playback rapidly. Releasing the button returns the unit to normal playback.



To locate the beginning of the scene or song

■ During playback

Press ►►| or |◄◄.

Press |◄◄ to locate the beginning of the current chapter, title, or track, and press ►►| to locate the beginning of the next chapter, title, or track.

NOTE

- When you play a Video CD disc with the PBC function or a DVD disc, the unit may locate a different place, but it will generally locate the beginning of the title, chapter or track.

Resuming playback

The unit stores the position on a disc where you want to interrupt playback and resumes playback from that position later.

To store the point you want to resume playback from



■ During playback

Press ■ or DVD ⏻/⏪.

The unit stores the current playback position of the disc.

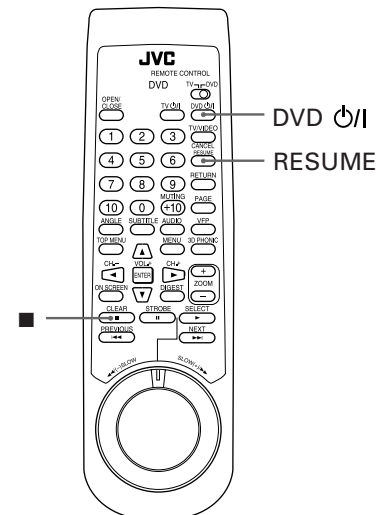

To resume playback from the stored point



■ While stopped or in the standby mode

Press RESUME.

The unit resumes playback from the stored position.

● To clear the memory

Take out the disc from the unit.



- The memory is also cleared when the unit starts playback in any manner.

NOTE

- When you press RESUME during playback of a Video CD disc with PBC function, the unit may resume playback from a point slightly earlier than the resume point you stored.

Advanced operations

This section describes advanced operations of the unit.

The following table shows the contents of this section together with effective disc types for each operation.

Function	DVD Video	DVD Audio	Audio CD	Video CD	Page
Playing from a specific position on a disc					
To locate a desired scene from the DVD menu	yes	yes			23
To locate a desired scene from the menu of the Video CD with PBC				yes	23
To locate a desired selection using the numeric buttons	yes	yes	yes	yes	24
To locate a desired chapter or track using ►► or ◀◀	yes	yes	yes	yes	24
To locate a desired chapter/track from the on-screen display [CHAP. SEARCH/TRACK SEARCH]	yes	yes*			25
To locate a desired position by specifying the time [TIME SEARCH]	yes	yes	yes	yes	25
To locate a desired scene from the digest display [DIGEST]	yes			yes	26
Special picture playback					
To advance a still picture frame-by-frame	yes			yes	27
To display continuous still pictures [STROBE]	yes			yes	27
To playback in slow-motion [SLOW]	yes			yes	28
To zoom in/out [ZOOM]	yes			yes	28
Changing the playback order					
To playback in the desired order [PROGRAM]		yes	yes	yes	29
To playback in random order [RANDOM]		yes	yes	yes	30
Repeat playback					
To repeat a current selection or all tracks [REPEAT]	yes	yes	yes	yes	30
To repeat a desired part [A-B REPEAT]	yes	yes	yes	yes	31
Selecting a scene angle of DVD Video					
To select a scene angle from the normal screen [ANGLE]	yes	yes*			32
To select a scene angle from the on-screen display [ANGLE]	yes				32
To select a scene angle from the angle list [ANGLE]	yes				33
Changing the language and sound					
To select the subtitle language [SUBTITLE]	yes	yes*			33
To select the audio language or sound [AUDIO]	yes	yes		yes	34
Miscellaneous functions					
To adjust the picture character [VFP]	yes	yes*		yes	35
To simulate surround sound [3D PHONIC]	yes		yes		36
To check the disc time [TIME SELECT]		yes	yes	yes	37
To select a still picture on a DVD Audio disc [PAGE]		yes			38
To playback a bonus group of a DVD Audio disc		yes			39

- In the table above, "yes*" shows that the corresponding function is effective to non-audio information (such as movies, still pictures and text data) if recorded on a DVD Audio disc.

NOTE

TV  DVD



When controlling the unit using the CURSOR, TV/VIDEO-CANCEL or numeric buttons, make sure that the TV-DVD switch is set to "DVD".

Playing from a specific position on a disc

You can play a disc from the selected track, title or chapter, or from the specified time.

To locate a desired scene from the DVD menu



DVD discs generally have their own menus which show the disc contents. These menus contain various items such as titles of a movie, names of songs, or artist information, and display them on the TV screen. You can locate a desired scene by using the menu.

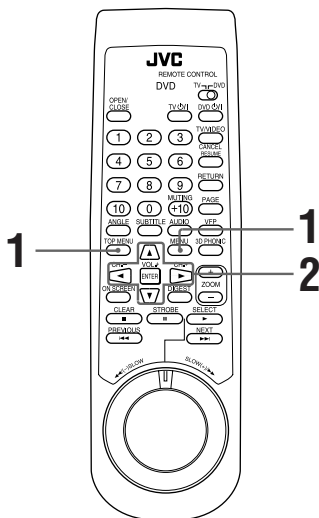

■ Whenever a DVD disc is loaded

1 Press MENU or TOP MENU.

The menu appears on the TV screen.



About menu

Normally, a DVD Video disc which contains more than one title may have a "title" menu which lists the titles. Similarly, a DVD Audio disc which contains more than one group may have a "top" menu which lists the groups. In such a case, the menu appears on the TV screen by pressing the TOP MENU button. Some DVD discs may also have a different menu which appears by pressing the MENU button.

See the instructions of each DVD disc for its particular menu.

2 Use CURSOR ◀/▶/▲/▼ to select a desired item, then press ENTER.

The unit starts playback of the selected item.



- With some discs, you can also select items by entering the corresponding number using the numeric buttons, which may cause the unit to automatically start playback.

Example

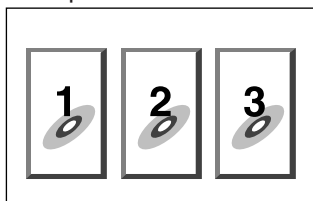

NOTES

- When appears on the TV screen by pressing TOP MENU in step 1:
The disc does not have a menu listing the titles or groups.
- When appears on the TV screen by pressing MENU in step 1:
The disc does not have a menu.

To locate a desired scene from the menu of the Video CD with PBC



Some Video CD discs support the PBC function. PBC is an abbreviation of "PlayBack Control." A Video CD disc recorded with PBC has its own menus such as a list of the songs. You can locate the specific scene by using the menu.

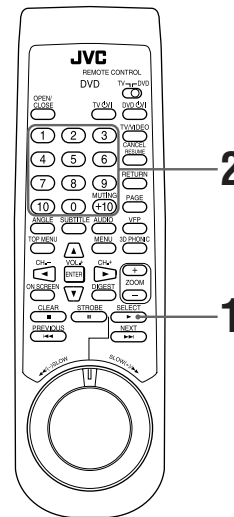

■ While a Video CD disc with PBC is stopped

1 Press ►.

A disc menu appears on the TV screen (The PBC function is activated).

"Pbc" is indicated in the display window on the front panel.

Example:

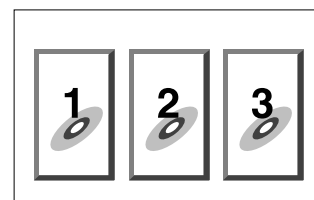

2 Use the numeric buttons to select the desired number of the item.

- See page 11 for details about how to use the numeric buttons.

The unit starts playback from the selected item.

You can return to the menu by pressing RETURN.

When "NEXT" or "PREVIOUS" appears on the TV screen, the unit generally works as follows:

- Pressing ►► turns to the next page.
- Pressing ◄◄ returns to the previous page.

* The method of the operation is different depending on the disc.

Hints

- To activate the PBC function when a PBC-compatible Video CD disc is being played back without the PBC function, press ■ then press ►.
- You can also activate the PBC function using the on-screen display as follows.
 1. Press ON SCREEN.
 2. Use the▲/▼ buttons to move [PBC CALL], then press ENTER.
- If you want to playback a PBC-compatible Video CD disc without activating the PBC function, start playback by using the numeric buttons instead of the ► button. See the next paragraph.

To locate a desired selection using the numeric buttons



You can locate the desired title or chapter (for DVD Video), group or track (for DVD Audio), or track (for Audio CD/Video CD) from which the unit starts playback.

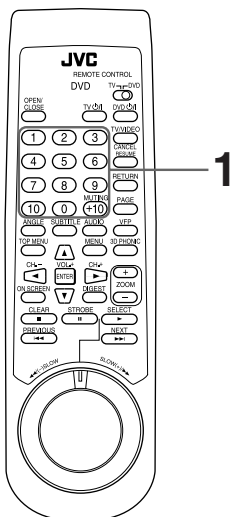

- For DVD Video/DVD Audio/Audio CD : During playback or while stopped
- For Video CD : During playback without PBC function or while stopped

- 1 Use the numeric buttons to specify the number.
The unit starts playback from the beginning of the selection.
Depending on the disc type and the unit status, what is specified differs.

Unit status	Disc type	What is specified
While stopped	DVD Video	title or chapter ^(a)
	DVD Audio	group or track ^(b)
	Audio CD/Video CD	track
During playback	DVD Video	chapter
	DVD Audio	track
	Audio CD/Video CD	track

- ^(a) If a disc contains more than one title, a title is specified. If a disc contains only one title, a chapter is specified.
- ^(b) If a disc contains more than one group, a group is specified. If a disc contains only one group, a track is specified.

The selected title, group or track number appears in the display window on the front panel.

Hints

You can also see the selected number on the on-screen display.

NOTES

- During DVD Video or DVD Audio playback, if a menu is shown on the TV display, you cannot use this function.
- When Ⓞ appears on the TV screen.
The title or track you have selected is not contained in the disc.
- This function does not work during Video CD playback with PBC function

To locate a desired chapter or track using ►► or ◄◄



You can locate the beginning of a chapter (for DVD Video) or track (for DVD Audio/Audio CD/Video CD) by pressing the ◄◄ or ►► button.

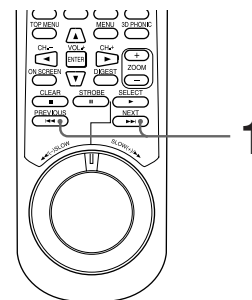

- For DVD Video : During playback
- For Audio CD/DVD Audio : During playback or while stopped
- For Video CD : During playback without PBC function

- 1 Press ►► or ◄◄.
 - To skip forward chapters/tracks, press ►► as many times as required.
 - To skip to the beginning of the current track/chapter, press ◄◄ once.
 - To skip back chapters/tracks, press ◄◄ as many times as required.

NOTES

- This function may not work with some DVD Video discs.
- This function may not work during Video CD playback with PBC function.

To specify a desired chapter/track from the on-screen display [CHAP. SEARCH/TRACK SEARCH]



When playing back pictures of a DVD Video or DVD Audio disc, you can specify the chapter/track number to be played from the on-screen display.

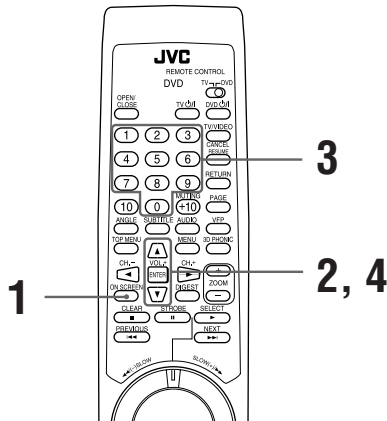

■ During playback of pictures

1 Press ON SCREEN.

The on-screen display appears on the TV screen.

2 Use CURSOR ▲/▼ to move to [CHAP. SEARCH] or [TRACK SEARCH], then press ENTER.

“GO TO CHAPTER = ” or “GO TO TRACK = ” appears in the message area.

The color of [CHAP. SEARCH] or [TRACK SEARCH] changes.

(DVD Video)

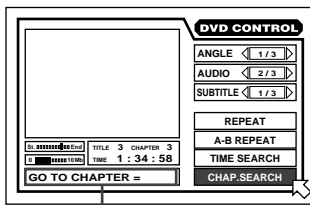

Message area

(DVD Audio)

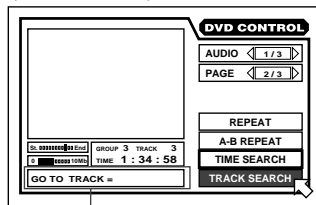

Message area

3 Use the numeric buttons (0 ~ 9) to enter the desired chapter/track number.

Example:

To select chapter/track number 8: Press “8” → ENTER.
 To select chapter/track number 37: Press “3” → “7” → ENTER.

The specified number appears in the message area.

4 Press ENTER.

The unit starts playback from the specified selection.



The “10” and “+10” buttons are not used in this function.

NOTES

- When the number is incorrect in step 3: Overwrite the incorrect number with the correct number.
- When is displayed in the TV screen in step 4: The disc does not have the chapter or track you have selected or does not accept the chapter/track search function.
- To return to the regular display: Press ON SCREEN.
- You cannot use this function with a DVD Audio disc that does not contain any picture.

To locate a desired position by specifying the time [TIME SEARCH]



You can play a disc from the desired position by specifying the elapsed time from the beginning of the current title (for DVD Video), the current group (for DVD Audio) or the disc (for Audio CD/Video CD) using the TIME SEARCH function.

Note that some DVD Video discs do not contain time information, and the TIME SEARCH function cannot be used.

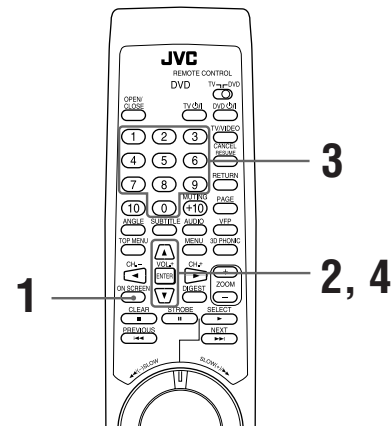

- For DVD Video : During playback
- For DVD Audio/Audio CD : During playback or while stopped
- For Video CD : During playback without PBC function or while stopped

1 Press ON SCREEN.

The on-screen display appears on the TV screen.

2 Use CURSOR ▲/▼ to move to [TIME SEARCH], then press ENTER.

“GO TO” appears in the message area.

The color of [TIME SEARCH] changes.

3 Use the numeric buttons (0 ~ 9) to enter the time.

The specified time appears in the message area.

4 Press ENTER.

The unit starts playback from the specified time.

• Screen examples:

(during DVD Video playback)

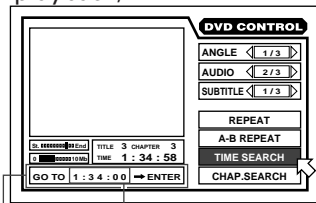

Message Selected time area

(Audio CD)

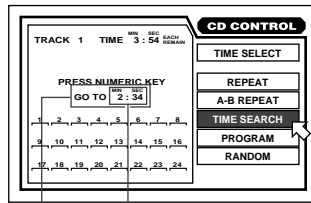

Message Selected time area

Hints

- "10" and "+10" buttons are not used in this function.
- You can specify the time in hour/minute/second format for DVD Video/Audio discs, and in minute/second format for Audio and Video CD discs.

Example (for DVD):

To playback from 2(H):34(M):00(S)

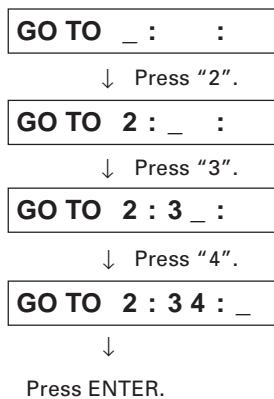

You do not have to press "0" to enter the trailing zeros (for the last two digits in the example above). Of course, it is possible to enter them.

- When you make a mistake
Move the cursor to the incorrect value, then press the correct button to re-select the value.

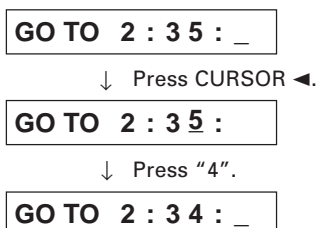

NOTES

- While a DVD Audio disc is stopped, you can specify the elapsed time from the beginning of group 1.
- When appears on the TV screen in step 2 or 4:
The time you have selected is not contained on the disc, or the time search function does not work on the disc.
Also note that the time search function does not work during Video CD playback with the PBC function.
- To return to the regular display:
Press ON SCREEN .

To locate a desired scene from the digest display [DIGEST]



The unit can display the opening scene of each title or chapter on a DVD Video or each track of a Video CD. You can select a desired title or track from the opening scenes displayed on the TV screen.

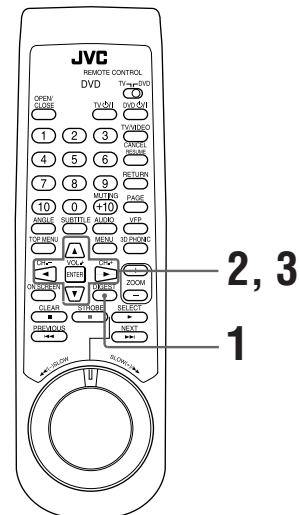

- For DVD Video : While stopped or during playback
- For Video CD : While stopped or during playback without PBC function.

1 Press DIGEST.

Up to nine opening scenes are displayed.

- While a DVD Video disc is stopped:
The opening scene of each title appears on the TV screen.
- During DVD Video playback:
The opening scene of each chapter in the current title appears on the TV screen.
- When a Video CD disc is loaded:
The opening scene of each track appears on the TV screen.

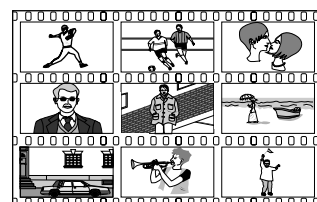

2 Use CURSOR ◀/▶/▲/▼ to select the desired scene.

The selected scene is surrounded with the heavy box.

If there are more than 9 scenes, the digest screen will have more than one page. In this case, pressing ▶▶ advances to the next page, while pressing ◀◀ returns to the previous page.

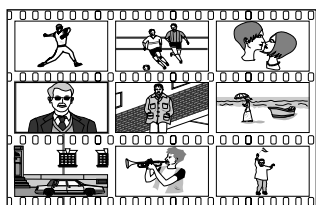

Selected scene

Hints

- When the lower right scene is selected, pressing CURSOR ▶ advances to the next page if available. Similarly, when the upper left scene is selected, pressing CURSOR ◀ returns to the previous page (if available).

3 Press ENTER.

The unit starts playback from the selected scene.

NOTE

- With some discs, depending on the contents, it may take some time until all the scenes appear on the screen.

Special picture playback

The unit provides special picture playback functions including Frame-by-frame, Strobe, Slow-motion and Zoom.

To advance a still picture frame-by-frame

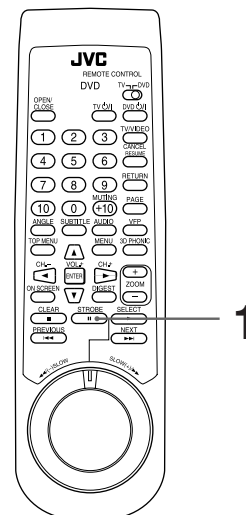

■ While paused

1 Press II.

Each time you press II, the still picture advances to the next frame.

Pressing ▶ returns to normal playback.

To display continuous still pictures [STROBE]

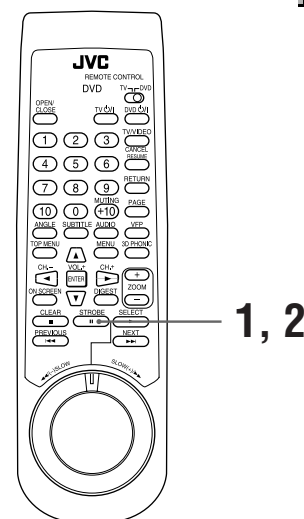

■ During playback

1 At the point you want to view as continuous photographs, press II.

The unit pauses playback.

2 Press and hold **II** for more than 1 second.

Nine continuous still pictures appear on the TV screen.

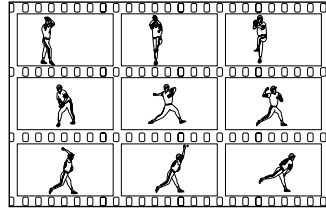

Hints

- Pressing **II** when the still pictures appear advances to the next still picture.
- To cancel strobe play**
Press and hold **II** for more than 1 second.

NOTE

- If you press and hold **II** for more than 1 second during playback, nine still pictures also appear but they advance in realtime.

To playback in slow-motion [SLOW]

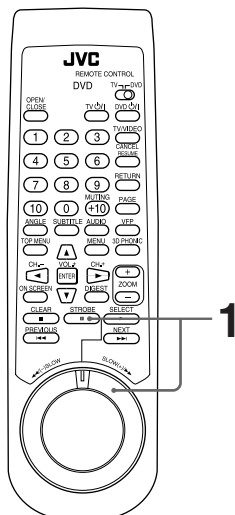

- During playback

1 Press **II**, then use the SHUTTLE knob.

To play forward slow-motion, turn the SHUTTLE knob to the right. To play reverse slow-motion (for DVD Video discs only), turn it to the left. The more you turn the knob, the more the slow-motion speed increases.

- To return to normal playback**
Press **▶**.
- To pause slow-motion playback**
Release the SHUTTLE knob.

NOTES

- The sound is muted during slow-motion playback.
- Reverse slow-motion playback is not possible for a Video CD.

To zoom in/out [ZOOM]

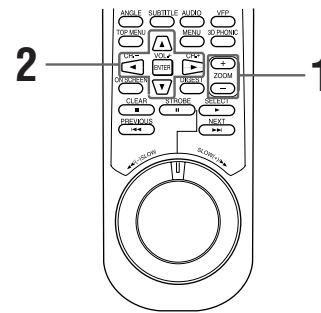

- During playback or while paused

1 Press ZOOM + or -.

The unit zooms in by pressing ZOOM + or zooms out by pressing ZOOM -. Each time you press ZOOM +, the magnification is doubled (up to x 1024). Each time you press ZOOM -, the magnification is halved (down x to 1/8).

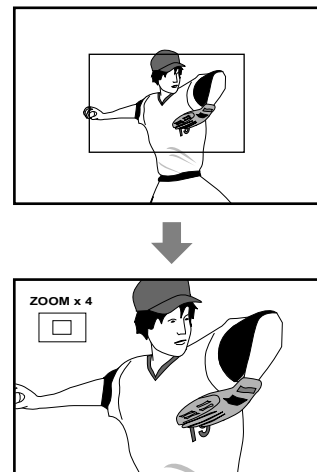

At the top-left of the screen, the information for the current magnification appears, as well as the zoomed-in position of the scene that can be moved by operating the next step.

2 Use CURSOR **◀/▶/▲/▼** to move the zoomed-in position.

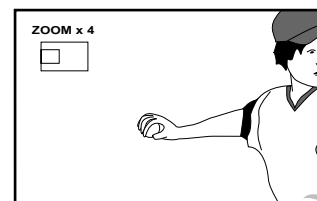

- To return to normal playback**
Press **ENTER**.

NOTE

- While zoomed in, the picture may look coarse.

Changing the track order

You can play tracks on a DVD Audio, Audio CD or Video CD in the desired order or in random order.

To playback in the desired order [PROGRAM]



By programming tracks, you can play up to 24 tracks in any order. You may program the same track more than once.

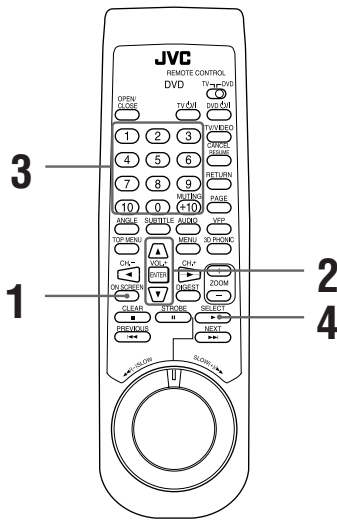

■ While stopped

1 Press ON SCREEN.

The on-screen display appears on the TV screen.

2 Use CURSOR ▲/▼ to move to [PROGRAM] and press ENTER.

The color of [PROGRAM] changes.

(for DVD Audio)

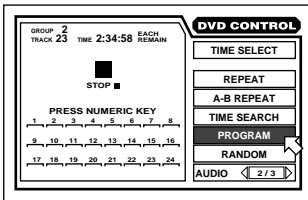

(for Audio CD)

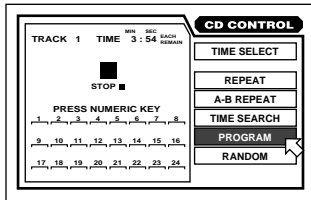

(for Video CD)

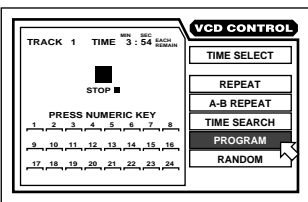

3a (for Audio CD/Video CD)

Specify tracks in the desired order using the numeric buttons.

3b (for DVD Audio)

Specify selections in the desired order by group and track numbers using the numeric buttons.

For each program step, using the numeric buttons, specify a group first, then specify a track.

For example, to specify "track 14 in group 2",

Press 2 → +10 → 4

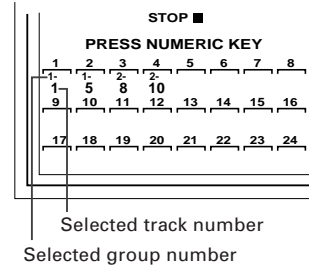

• **When you make a mistake**

Press TV/VIDEO – CANCEL. The last selection programmed is erased.

4 Press to start program play.

When all of the programmed tracks have finished playback, the unit stops but the program remains.

• **To clear the program**

While stopped and the on-screen display is shown on the TV screen, move to [PROGRAM] and then press . All the programmed tracks are erased.

• **To quit program playback**

Press ENTER when points [PROGRAM]. [PROGRAM] returns to its original color.

(When playing back a Video CD, you have to press and then press ON SCREEN to display the on-screen display.)



- While programming tracks, the current program step number, as well as the selected track number (and group number for a DVD Audio disc), is indicated in the display window.
- During program playback, the current step number, as well as the selected track number (and group number for a DVD Audio disc), is indicated in the display window.
- If you are going to program a track in the bonus group of a DVD Audio, the unit will ask you to enter the password for the bonus group (see page 39).
- You can add tracks to the program during program playback of Audio CD.

To playback tracks in random order [RANDOM]

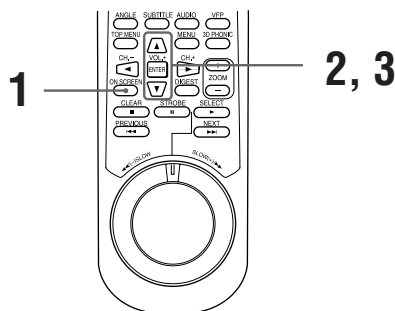

You can play tracks in random order.

■ While stopped

1 Press ON SCREEN.

The on-screen display appears on the TV screen.

2 Use CURSOR ▲/▼ to move to [RANDOM].

(for DVD Audio)

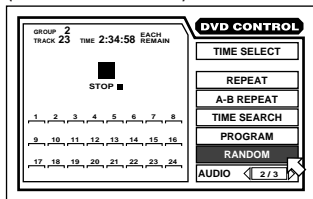

(for Audio CD)

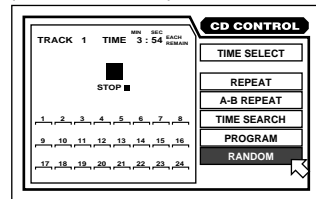

(for Video CD)

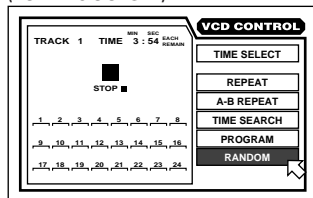

3 Press ENTER.

The unit starts random playback.
The color of [RANDOM] changes.



- When all tracks have been played once, random play ends.
- The same track will not be played back more than once during random play.
- During Audio CD playback, pressing ENTER when points [RANDOM] quits random mode and continues playback in the normal order.
- In the random playback mode, tracks in the bonus group are not played back (see page 39).
- **To quit random playback**
Press ■. The unit stops playback and quits random mode.

Repeat playback

You can repeat playback of the current title or chapter (for DVD Video), current group or track (for DVD Audio), or current or all tracks. You can also repeat playback of a desired part.

To repeat a current selection or all tracks [REPEAT]

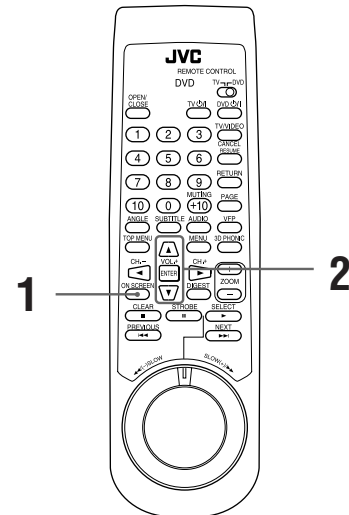

■ For DVD Video/DVD Audio/Audio CD :
During playback

For Video CD : During playback without PBC function

1 Press ON SCREEN.

The on-screen display appears on the TV screen.

2 Use CURSOR ▲/▼ to move to [REPEAT], then press ENTER.

Each time you press ENTER, the repeat mode changes as follows:

• for DVD Video

The current title or chapter is played repeatedly.

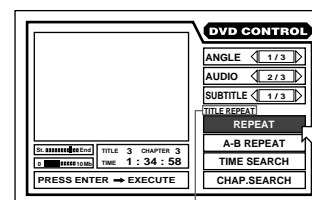

The selected repeat mode appears on the TV screen.



• for DVD Audio

The current track, or all tracks in the current group is/are played repeatedly.

(for DVD Audio)

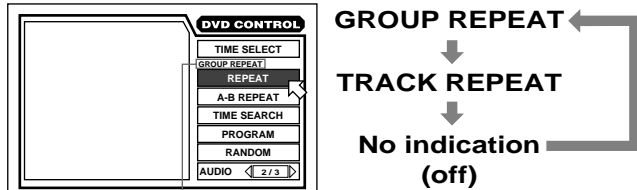

Selected repeat mode

• for Audio CD/Video CD

The current track or all tracks is/are played repeatedly.

(for Audio CD)

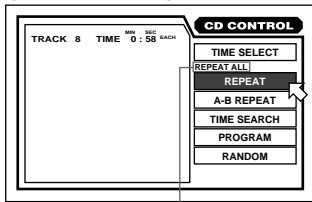

Selected repeat mode

(for Video CD)

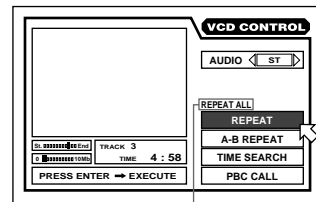

Selected repeat mode

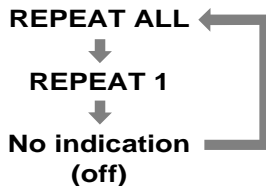

• To stop repeat playback

Press ■.

When a DVD Video disc is set, the unit stops playback and quits repeat mode.

When a DVD Audio, Audio CD or Video CD disc is set, the unit stops playback but remains in repeat mode.

• To quit repeat playback

When the cursor points [REPEAT], press ENTER repeatedly until [REPEAT] returns to its original color.

NOTES

- When the program function is active with a DVD Audio, Audio CD or Video CD disc, the repeat mode changes as follows.

REPEAT ALL
(All the programmed tracks are played repeatedly.)

REPEAT 1
(The current track is played repeatedly.)

No indication (off)

- Repeat play function cannot be used during Video CD playback with PBC function.
- To turn off the on-screen display
Press ON SCREEN.
- If a symbol appears when pressing ENTER in step 2 during DVD Video playback
You cannot repeat the title or chapter because of the disc contents.

To repeat a desired part [A-B REPEAT]

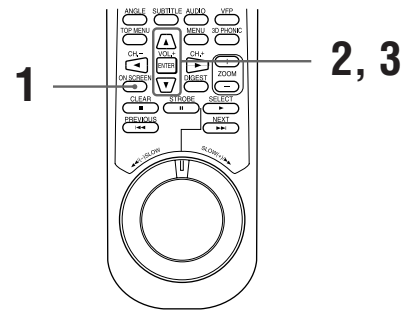

■ During playback

1 Press ON SCREEN.

The on-screen display appears on the TV screen.

2 Use CURSOR ▲/▼ to move to [A-B REPEAT], then press ENTER at the beginning of the part you want to repeat (point A).

The color of [A-B REPEAT] changes.

3 Press ENTER at the end of the part you want to repeat (point B).

The unit locates "A" and starts repeat playback between "A" and "B."

Point B must be in the same title or track as point A.

(for DVD Audio)

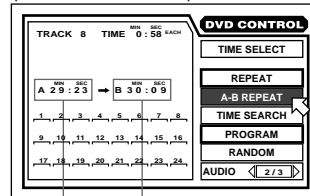

Point A Point B

(for DVD Video)

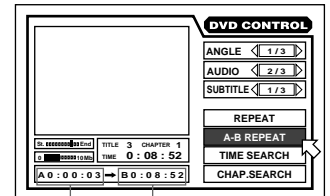

Point A Point B

(for Audio CD)

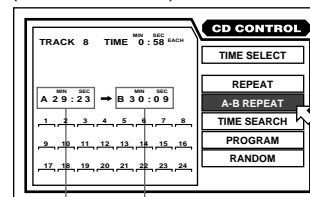

Point A Point B

(for Video CD)

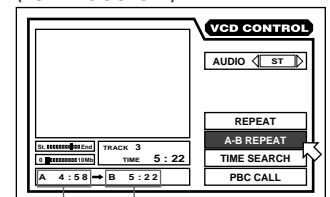

Point A Point B

• To quit A-B repeat playback

Press ■. The unit stops playback and quits A-B repeat mode.



During playback, pressing ENTER when the cursor points [A-B REPEAT] quits A-B repeat mode and continues playback.

NOTES

- To turn off the on-screen display
Press ON SCREEN.
- If a symbol appears when pressing ENTER in step 2 during DVD Video playback
You cannot repeat the selected portion because of the disc contents.

Selecting a scene angle of DVD Video

You can enjoy a variety of scene angles if the DVD Video disc contains "multi-angle" parts, where multiple cameras were used to shoot the same scene from different angles. You can select one of these viewing angles from the normal screen or on-screen display.



At the beginning of "multi-angle" parts, appears on the TV screen.

To select a scene angle from the normal screen [ANGLE]

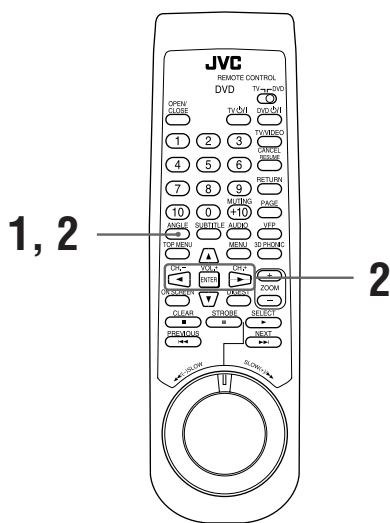

■ During playback

1 Press ANGLE.

The Angle selection display appears on the TV screen

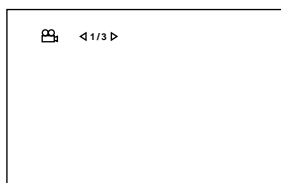

2 Press ANGLE or CURSOR <left>/<right> to select the desired angle.

Each time you press ANGLE or CURSOR <left>/<right>, the angle changes.

To select a scene angle from the on-screen display [ANGLE]

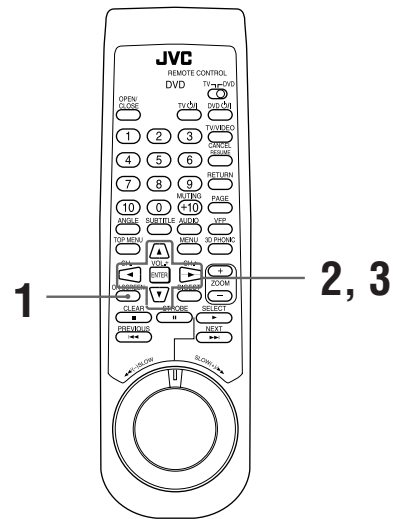

■ During playback

1 Press ON SCREEN.

The on-screen display appears on the TV screen.

2 Use CURSOR <up>/<down> to move to [ANGLE].

The total number of recorded angles

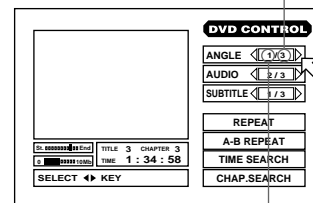

The current angle number

3 Use CURSOR <left>/<right> to select the desired angle number.

Example:

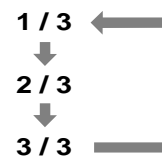

NOTES

- **To turn off the on-screen display**
Press ON SCREEN.
- **When appears on the TV screen**
The current scene is not recorded from multiple angles.
- **To move to [ANGLE] or select the angle in the on-screen display, you may use the ANGLE button instead of CURSOR <up>/<down> in steps 2 and 3 above.**

To select a scene angle from the angle list [ANGLE]

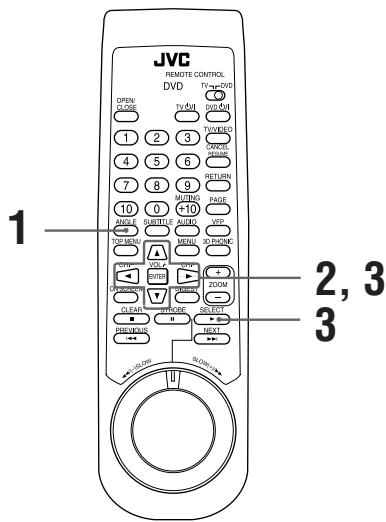

■ During playback

- 1 Press and hold ANGLE for more than 1 second.

Up to nine camera angles recorded on a disc appear on the TV screen.

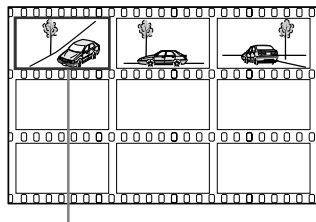

The selected camera angle

- 2 Use CURSOR ▲/▼/◀/▶ to select the desired angle.

- 3 Press ENTER or ▶.

The unit starts playback by the selected angle on the full-screen.

NOTES

- When appears on the TV screen in step 1: The current scene is not recorded from multiple angles.
- During the operation above, audio is muted.

Changing the language and sound

Some DVD Video discs have more than one subtitle language or/and audio language/sound, while some DVD Audio discs have more than one audio language/sound.

You can select the desired one from them. Similarly, you can select the audio channel(s) of a Video CD disc.

To select the subtitle language [SUBTITLE]



■ During playback

From normal display

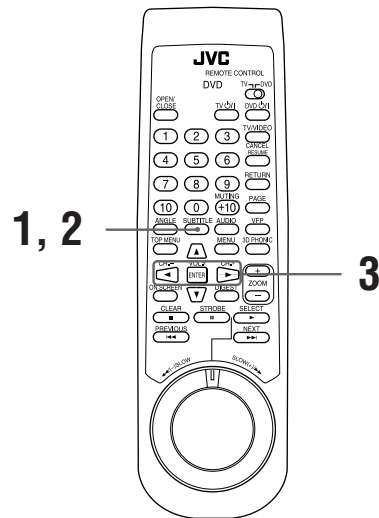

- 1 Press SUBTITLE.

The Subtitle selection display appears on the TV screen.

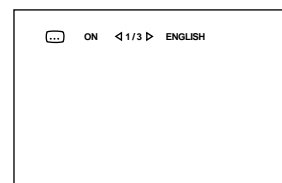

- 2 To turn the subtitle on and off, press SUBTITLE.

- 3 To select the subtitle language, press CURSOR ◀/▶.

From on-screen display

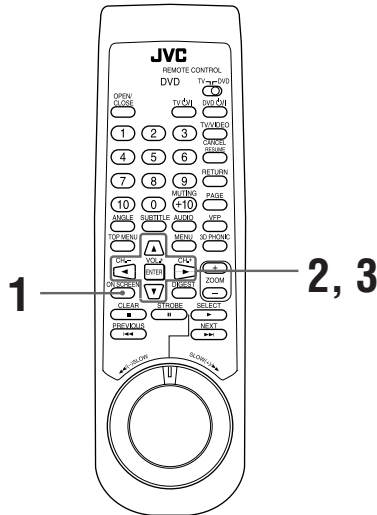

- 1 Press ON SCREEN.
The on-screen display appears on the TV screen.
- 2 Use CURSOR ▲/▼ to move to [SUBTITLE].

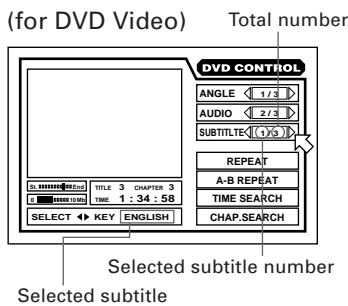

- 3 Use CURSOR ◀/▶ to select the desired subtitle.
Each time you press CURSOR ◀/▶, the subtitle changes.
Example:

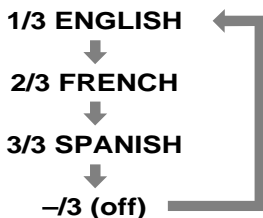

NOTES

- To move to [SUBTITLE] or select the subtitle in the on-screen display, you may use the SUBTITLE button instead of the CURSOR buttons in steps 2 and 3 above.
- The selected language may be abbreviated on the TV screen. See "Appendix A: Table of languages and their abbreviations" in this manual.
- When appears on the TV screen: You cannot select the subtitle.

To select the audio language or sound [AUDIO]



■ During playback

From normal display

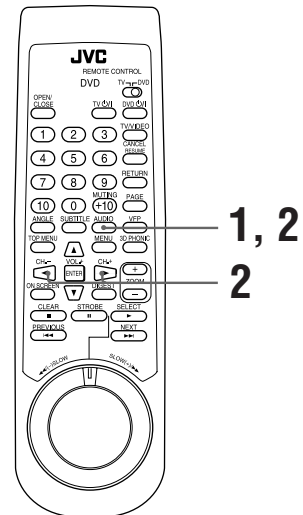

- 1 Press AUDIO.
The Audio selection display appears on the TV screen.

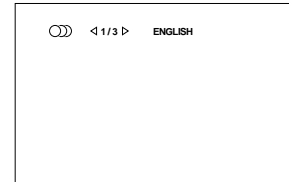

- 2 Use AUDIO or CURSOR ◀/▶ for audio selection.

From on-screen display

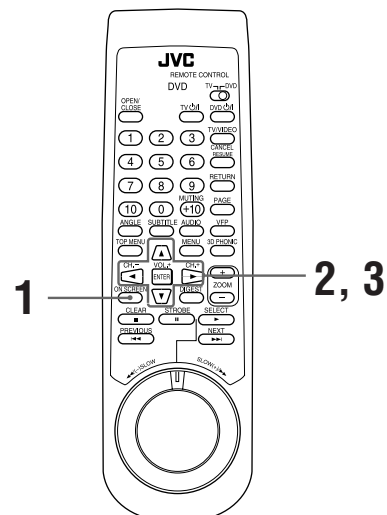

SHARPNESS

Controls the sharpness of the screen.

GAMMA

Controls the brightness of neutral tints with maintaining the brightness of dark and bright portions.

TINT

Controls the tint of the screen.

COLOR

Controls the color depth of the screen.

Y DELAY

Controls the color gap of the screen.

3 Adjust the level of the parameter using CURSOR ◀▶.

Moving the adjusting bar to the left reduces the effect, while moving the bar to the right enhances the effect.

NOTE

• The number of setting steps depends on parameters.



The VFP screen disappears if no operations are made for more than 10 seconds. You can also turn off the VFP screen manually by pressing ENTER.

To simulate surround sound [3D PHONIC]



Using the 3D PHONIC function, you can get a simulated surround effect from your stereo system.

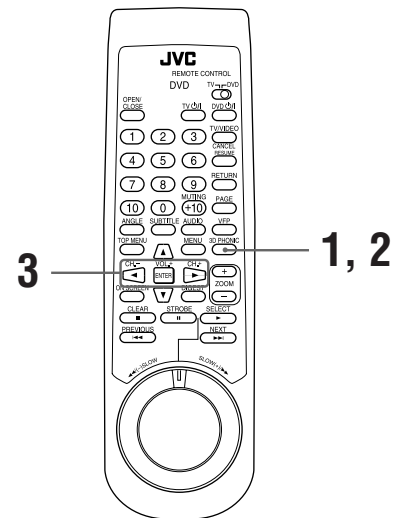

■ During playback

- 1 Press 3D PHONIC.
- 2 Select the desired effect mode by pressing 3D PHONIC.

Each time you press 3D PHONIC, the mode changes as follows:



Selected effect mode

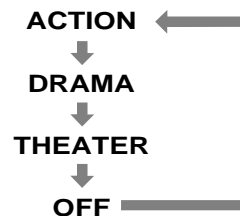

- **ACTION**
Suitable for action movies and sports programs in which sounds dynamically move.
- **DRAMA**
Natural and warm sound. You can enjoy movies in a relaxed mood.
- **THEATER**
You can enjoy sound effects like in a major theater in Hollywood.

3 Press CURSOR ◀▶ to adjust the effect level.

You can adjust the effect level in 5 steps.

- Toward L:
Reduces the effect.
- Toward H:
Enhances the effect.



Effect level

Hints

To turn off the 3D PHONIC screen, press ENTER. The 3D PHONIC screen disappears if no operations are made for more than 10 seconds.

NOTES

- The 3D PHONIC function works correctly only when playing back a DVD Video disc recorded with the Dolby Digital or Dolby Surround and Audio CD. Otherwise, it does not work at all.
- When playing back a DVD Video disc recorded with the Dolby Digital that does not contain the rear signal, you cannot get a correct 3D Phonic sound though you can change the 3D PHONIC setting.
- The 3D PHONIC function does not affect the Dolby Digital bitstream signal from the DIGITAL output jack.
- When you set the 3D PHONIC function is active, the "DOWN MIX" and "COMPRESSION" setting in the "PREFERENCE 2" display are disabled.

To check the disc time [TIME SELECT]



You can choose the time display mode for a DVD Audio, Audio CD or Video CD disc in the display on the front panel and in the on-screen display.

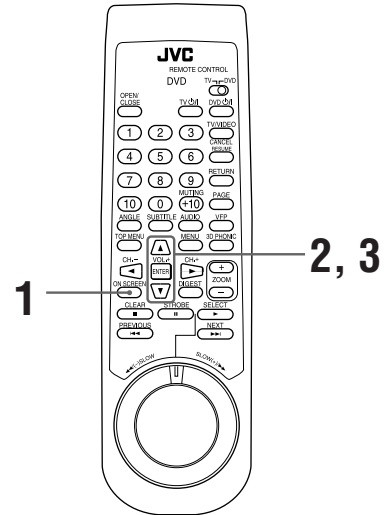

- For DVD Audio : During playback of audio only or while stopped
- For Audio CD : During playback or while stopped
- For Video CD : While stopped

1 Press ON SCREEN.

The on-screen display appears on the TV screen.

2 Use CURSOR ▲/▼ to move to [TIME SELECT].

(for DVD Audio)

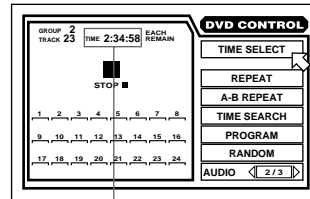

Time display

(for Audio CD)

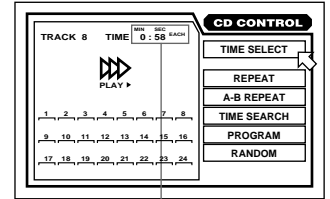

Time display

(for Video CD)

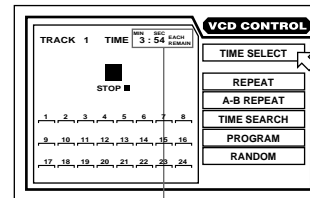

Time display

3 Press ENTER.

Each time you press ENTER, the time mode changes as follows:

- During playback (for DVD Audio/Audio CD)

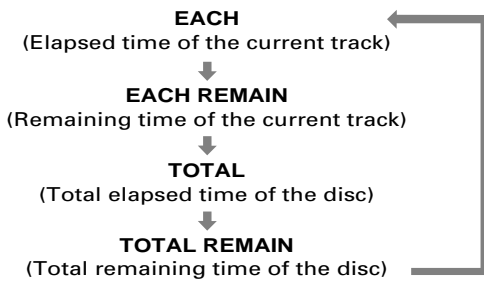

- While stopped

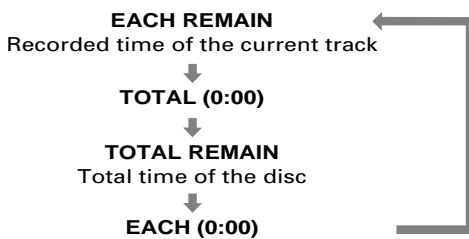

When you select "EACH REMAIN" while stopped, you can change the track by pressing ◀▶ or ▶▶.

To select a still picture on a DVD Audio disc [PAGE]



Most DVD Audio discs include still pictures, which usually appear in turn automatically during playback according to the playback sequence. However, when "B.S.P." lights in the display window during playback, there are other page(s) of the current still picture and you can change the picture (turn the page) manually.



At the beginning of a part where there are selectable pictures, "PAGE" (or a corresponding word of the current display language) appears on the TV screen.

- While "B.S.P." in the display window lights during playback

From normal display

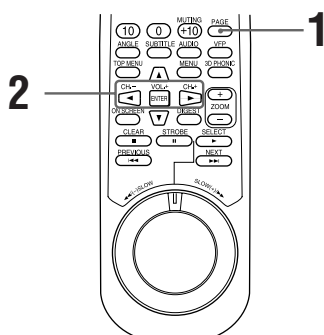

1 Press PAGE.

The page selection display appears on the TV screen.

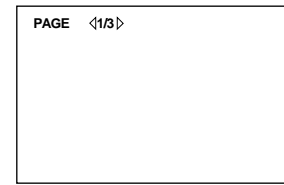

2 Use CURSOR ◀▶ to select the desired page.

NOTE

- You can also advance to the next page by pressing the PAGE button.

From on-screen display

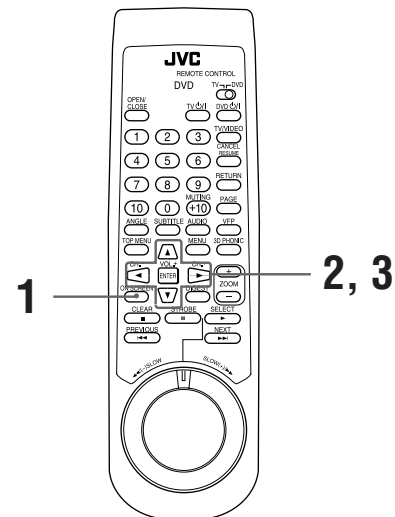

1 Press ON SCREEN.

The on-screen display appears on the TV screen.

2 Use CURSOR ▲/▼ to move [PAGE].

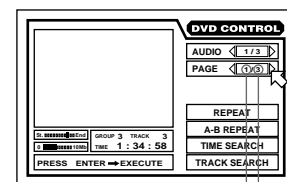

Total number

Selected page number

3 Use CURSOR ◀▶ to select the desired page.

Each time you press CURSOR ◀▶, the page changes.

NOTE

- To move [PAGE] or select the page in the on-screen display, you may use the PAGE button instead of CURSOR ▲/▼ in steps 2 and 3 above.

To playback a bonus group of a DVD Audio disc



Some DVD Audio discs contain a special group called "bonus group" whose contents are not opened to the public. When loading a disc with a bonus group, "BONUS" indicator lights in the display window. The bonus group is always assigned to the last group of a disc (for example, if a disc contains four groups including a bonus group, "group 4" is the bonus group).

To playback a bonus group, you have to enter the specific password for the bonus group. A way of getting the password depends on discs. After getting the password, you can playback the bonus group by the following procedure.

■ While a disc containing a bonus group is stopped

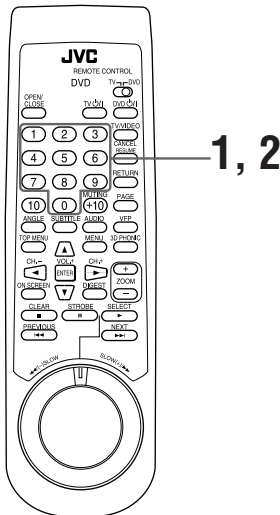

NOTES

- If you specify a track in the bonus group when programming tracks for the program playback, the display window will also show the above display for inquiring the password.
- In the random playback mode, tracks in the bonus group are not played back.
- To turn off the password entry display, operate any one of the following.
 - * Press ■.
 - * Open the disc tray.
 - * Turn the power off.

1 Select the bonus group number (the last group) using the numeric buttons.

The display window and on-screen display prompt you to enter the password as shown below.

(Display window)



(TV screen)

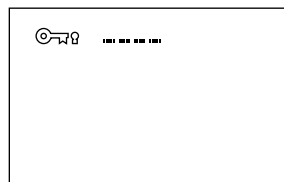

2 Enter the password using the numeric buttons (0 to 9).

If you enter the password correctly, the unit starts playback of the bonus group.

If you enter the wrong password, the display window shows the same as above.

Selecting preferences

You can set various preferences for playback and speaker settings via the "PREFERENCE" and "SPK. SETTING" display.

How to set preferences on the "PREFERENCE" display

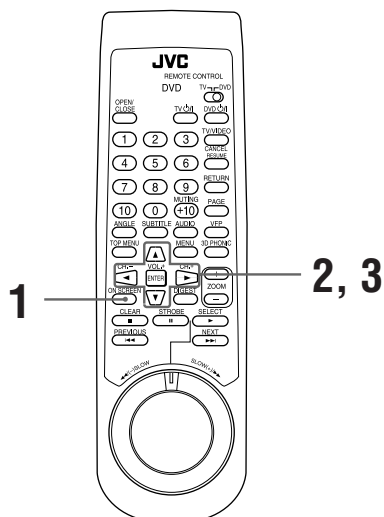

1 While a DVD Video disc is stopped or no disc is inserted, press ON SCREEN.

The on-screen display appears on the TV screen. "Preference 1", "Preference 2" and "Speaker setting" displays are available. To select the display, move to the desired tab using CURSOR /

Preference 1

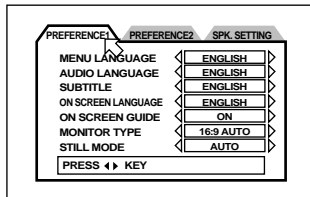

Preference 2

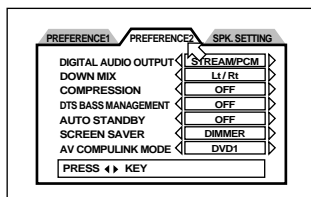

Speaker Setting

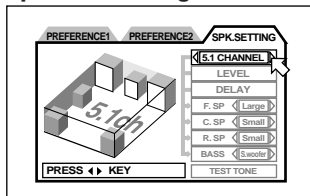

2 Move to select the item you want to set by using CURSOR .

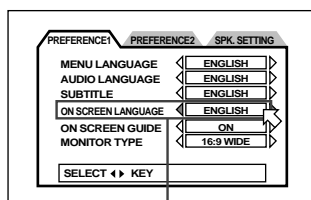

Selected item

3 Press CURSOR /

- To return to the normal screen, press ON SCREEN.
- For details about each setting, see the following paragraphs.

To set the language and display preference items

PREFERENCE 1 can be set as follows:

MENU LANGUAGE

You can select the default "display" language to be displayed if it is contained on a DVD disc.

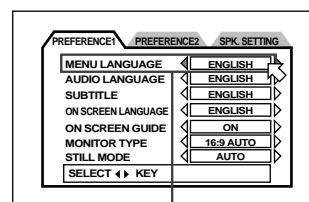

Selected language

Each time you press CURSOR , the language setting changes in the following order:

ENGLISH → SPANISH → FRENCH → CHINESE → GERMAN → ITALIAN → JAPANESE → language code from AA to ZU

(See "Appendix A: Table of languages and their abbreviations".)

Pressing CURSOR changes the language setting in the reverse order of the above.

* If the selected language is not recorded, the disc's default display language will be displayed.

AUDIO LANGUAGE

You can select the default audio language to be played if it is contained on a DVD disc.

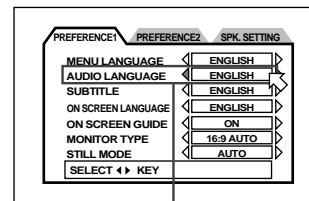

Selected language

Each time you press CURSOR , the language setting changes in the following order:

ENGLISH → SPANISH → FRENCH → CHINESE → GERMAN → ITALIAN → JAPANESE → language code from AA to ZU

(See "Appendix A: Table of languages and their abbreviations".)

Pressing CURSOR changes the language setting in the reverse order of the above.

* If the selected language is not recorded, the disc's default audio language will be played.

SUBTITLE

You can select the default subtitle language to be displayed if it is contained on a DVD disc.

Each time you press CURSOR ►, the language setting changes in the following order:

ENGLISH → SPANISH → FRENCH → CHINESE → GERMAN → ITALIAN → JAPANESE → language code from AA to ZU → OFF
(See "Appendix A: Table of languages and their abbreviations".)

Pressing CURSOR ◀ changes the language setting in the reverse order of the above.

* If the selected language is not recorded, the disc's default subtitle language will be displayed.

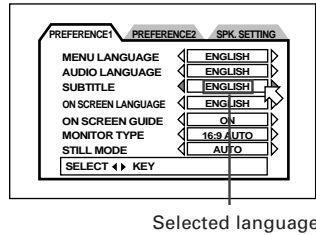

ON SCREEN LANGUAGE

You can select the on-screen display language to be displayed.

Each time you press CURSOR ►, the language setting changes as follows:

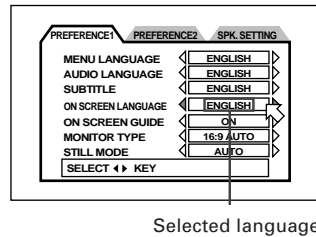

English	ON SCREEN LANGUAGE ◀ ENGLISH ▶
French	LANGUE D'ECRAN ◀ FRANCAIS ▶
Spanish	IDIOMA EN PANTALLA ◀ ESPAÑOL ▶
German	BILDSCHIRMENÜ-SPRACHE ◀ DEUTSCH ▶
Chinese (Simplify)	字幕语言 ◀ 中国語 ▶
Chinese (Traditional)	字幕語言 ◀ 中國語 ▶
Japanese	オンスクリーン言語 ◀ 日本語 ▶

Pressing CURSOR ◀ changes the language setting in the reverse order of the above.

ON SCREEN GUIDE

The unit can display "on-screen guide" icons or characters on the picture, which show what is happening to the disc or the unit.

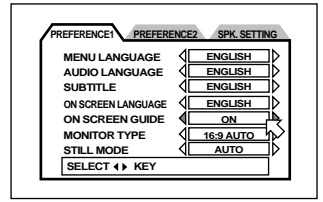

- **ON**
The on-screen guide will be displayed.
- **OFF**
The on-screen guide will not be displayed.

Examples of "on-screen guide" icons or characters:



MONITOR TYPE

You can select the monitor type to match your TV when you playback DVD Video discs recorded for wide screen televisions.

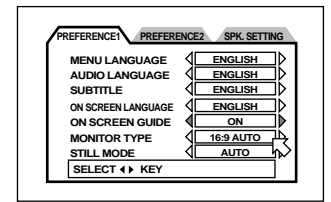

- **4:3 LB** (Letter Box Conversion)
When you connect the unit to a normal TV.

When you play a wide picture recorded on a DVD Video disc, the picture is displayed with bands across the upper and lower portions of the screen.



- **4:3 PS** (Pan Scan Conversion)
When you connect the unit to a normal TV.

When you play a wide picture recorded on a DVD Video disc, a portion of the picture is automatically cut off from the left and right sides of the image.

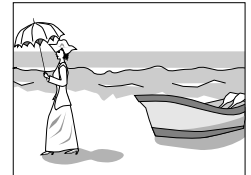

Depending on the disc, it may not be possible to playback in this mode. In such a case, the picture is played back as in 4:3 LB mode.

- **16:9 AUTO** (Wide Television screen)

When you connect the unit to a general wide-screen TV that automatically sets the aspect ratio according to an input signal, select this option.



- **16:9 NORMAL** (Wide Television screen)
When you connect the unit to a wide-screen TV that displays pictures in 16:9 aspect ratio regardless of an input signal, select this option. The unit automatically sets and outputs a recorded signal in correct aspect ratio to the TV.

NOTE

- If you playback a 4:3 source in "16:9 NORMAL" mode, the picture character changes because the unit converts the picture width.

STILL MODE

By selecting the still mode from the following options properly, you can get better still pictures.

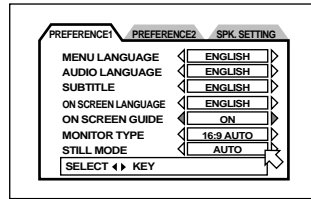

- **AUTO**
The unit automatically recognizes the picture type (film or video source) of the current disc.
- **FIELD**
Suitable for playing back a video source disc.
- **FRAME**
Suitable for playing back a film source disc.

To set audio and other preference items

PREFERENCE 2 can be set as follows:

DIGITAL AUDIO OUTPUT

To connect the unit's digital output to an external device equipped with a digital input, this item must be set correctly.

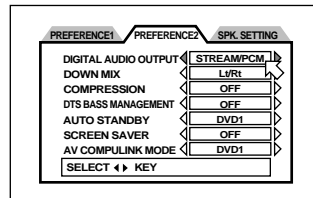

- **PCM ONLY:**
When you connect the DIGITAL OUT jack of the unit to the linear PCM digital input of other audio equipment.
- **STREAM/PCM:**
When you connect to the digital input of an amplifier with a built-in DTS, Dolby Digital or MPEG Multichannel decoder.
- **DOLBY DIGITAL/PCM:**
When you connect to the digital input of a Dolby Digital decoder, or an amplifier with built-in Dolby Digital decoder.

The following chart shows the relationship between types of playback discs and digital audio output signals.

Playback discs	Digital audio output		
	STREAM/PCM	DOLBY DIGITAL/PCM	PCM ONLY
DVD with 48/44.1-kHz, 16-bit linear PCM/MLP	48/44.1-kHz, 16-bit stereo linear PCM	←	←
DVD with 48/44.1-kHz, 20/24-bit linear PCM/MLP	48/44.1-kHz, 20-bit stereo linear PCM	←	←
DVD with 96/88.2-kHz, linear PCM/MLP	No output	←	←
DVD with 192/176.4-kHz, 16/20/24-bit linear PCM/MLP	No output	←	←
DVD with DTS	DTS bitstream	48-kHz, 16-bit linear PCM	←
DVD with Dolby Digital	Dolby Digital bitstream	←	48-kHz, 16-bit linear PCM
DVD with MPEG Multichannel	MPEG bitstream	48-kHz, 16-bit linear PCM	←
Video CD	44.1-kHz, 16-bit linear PCM	←	←
Audio CD	44.1-kHz, 16-bit linear PCM	←	←
Audio CD with DTS	DTS bitstream	44.1-kHz, 16-bit linear PCM	←

DOWN MIX

To playback a DVD Video disc recorded with surround multichannel audio correctly, the DOWN MIX setting must be properly made according to your audio system.

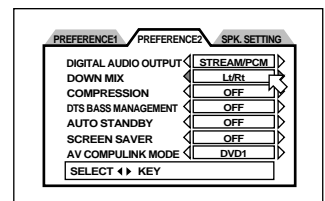

Note that this setting affects the output signal from the AUDIO (both DIGITAL and ANALOG) output jacks when playing back a DVD Video disc recorded with surround multichannel audio.

- **Lt/Rt**
When you enjoy multichannel surround audio by connecting the unit's AUDIO output (normally, the DIGITAL output) to a surround decoder.
- **Lo/Ro**
When you enjoy conventional 2-channel stereo audio by connecting the unit's AUDIO output(s) to a stereo amplifier/receiver or television set, or when you record audio of a DVD Video disc recorded with surround audio to your MD, cassette, etc.
- **OFF**
When you enjoy multichannel surround audio by connecting the unit's 5.1-channel audio outputs to an amplifier equipped with 5.1-channel inputs.

NOTES

- The DOWN MIX function does not work when the 3D PHONIC function is activated.
- Some DVD Audio discs prohibit the 2-channel down-mix. For such a disc, you cannot get the down-mixed signal even if you set "DOWN MIX" to "Lt/Rt" or "Lo/Ro".

COMPRESSION (only for Dolby Digital DVD Video Discs)

When enjoying a DVD Video disc recorded with the Dolby Digital 1-channel or 2-channel format at low or middle volume, setting COMPRESSION to ON makes you hear sound comfortably.

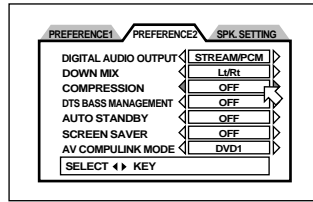

- **ON**
Audio is played back with the dynamic range compressed.
- **OFF**
Audio is played back as it was recorded.

NOTES

- The Compression function works only when playing back a disc recorded with DOLBY DIGITAL 1CH or 2CH. The setting is not effective for other discs.
- The Compression function does not work when the 3D PHONIC function is activated.

DTS BASS MANAGEMENT

This item controls the output signals when playing back DTS-encoded DVD Video discs.

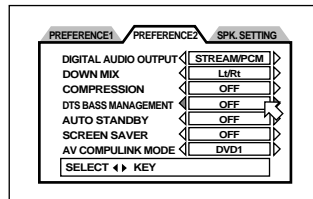

- **OFF**
This is the normal setting for DTS-encoded discs. Signals with the full frequency range are output from all speakers when playing back a DTS-encoded disc. This mode ignores all "Small" settings in the speaker setting screen (All "Small" settings are regarded as "Large").
- **ON**
All speaker settings (front, center and rear) in the speaker setting screen are effective when playing back DTS-encoded discs. The low frequency signal fed from the sub-woofer output is boosted up regardless of the "Bass redirect setting" in the speaker setting screen. See page 44 for the speaker setting screen.

AUTO STANDBY

When the unit is stopped for more than 30 minutes or 60 minutes, the unit enters standby mode automatically.

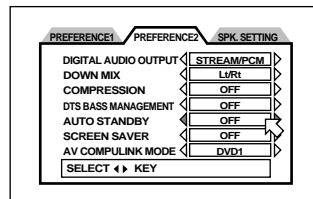

- **60**
Time is set to 60 minutes.
- **30**
Time is set to 30 minutes.
- **OFF**
The auto standby function is off.

SCREEN SAVER

A television monitor screen may be burned out if a static picture is displayed for a long time. To prevent this, the unit automatically activates the screen saver function if a static picture, such as an on-screen display or menu, is displayed for over several minutes.

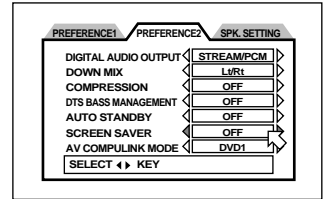

- **MODE 1**
The "screen saver" picture appears and scrolls.
- **MODE 2**
The "screen saver" picture appears and does not scroll.

(MODE 1)

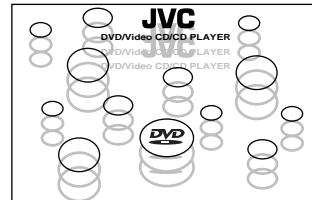

(MODE 2)

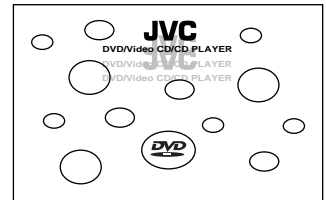

- **DIMMER**
The current picture gets dark.
- **OFF**
The screen saver function is off.

NOTES

- The monitor screen of a projector or projection TV is easily burned out if a static picture is displayed for a long time. Be careful not to allow the monitor screen to be burned out when you set the screen saver mode to "OFF".
- The TV screen may be garbled when you set the screen saver mode to "MODE 1". In this case, set to another mode.

AV COMPULINK MODE

This item is provided for use in the future. Leave it as the default setting ("DVD1").

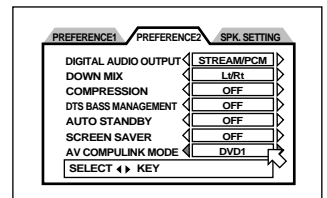

Speaker setting

Select the speaker configuration type according to your speaker system. Normally, simply select "5.1 CHANNEL" or "2 CHANNEL". However, by selecting "EXPERT", you can make fine tuning to match your speaker system.

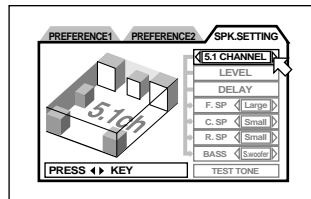

• 2 CHANNEL

When you connect to a 2-channel amplifier or TV.

• 5.1 CHANNEL

When you connect to a 5.1-channel amplifier and use the front, rear, center and sub-woofer speakers.

• EXPERT

When you want to make fine tuning to match your speakers. The following five setting items are available.

NOTES

- When selecting "5.1 CHANNEL" or "EXPERT", set "DOWN MIX" to "OFF" (see page 42).
- The Dolby Digital LFE (Low Frequency Effect) signal is always fed from the SUBWOOFER output on the rear panel of the unit regardless of speaker setting.
- If you connect the unit's digital output to an external Dolby Digital or DTS decoder (and set the "DIGITAL AUDIO OUTPUT" option to "STREAM/PCM"), the speaker setting above is not effective. Make the speaker setting of the external decoder properly.

Speaker size settings

(available only when selecting EXPERT)

Sets the speaker sizes according to your speakers.

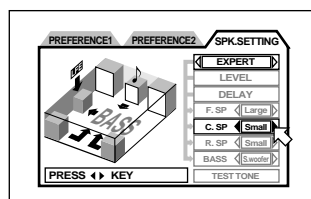

1 Select the speaker to be set using CURSOR ▲/▼.

- **F.SP:** front speakers
- **C.SP:** center speaker
- **R.SP:** rear speakers

2 Select the size using CURSOR ◀/▶.

- **Large:** large speaker(s) which can fully reproduce the low-frequency range.
- **Small:** small speaker(s) which can not fully reproduce the low-frequency range.
- **None:** No speaker(s) connected.

If you set the front speakers to "Small", you cannot set the other speakers to "Large".

Bass redirect

(available only when selecting EXPERT)

When you use small speakers which do not fully reproduce the low-frequency range, you can boost up the low-frequency signal of the sub-woofer or front speakers.

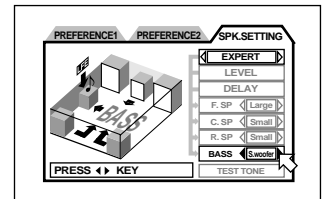

1 Select [BASS] using CURSOR ▲/▼.

2 Select [S. woofer] or [L/R] using CURSOR ◀/▶.

- **S.woofer:** The low-frequency signal fed from the sub-woofer output is boosted up.
- **L/R:** The low-frequency signals fed from the front speaker outputs are boosted up.

The "Bass redirect" setting is effective only when at least any one of the speaker sizes is set to "Small". If none of them is set to "Small", this setting is not activated ("None" appears in the setting field).

Please note that the "L/R" setting is effective only when playing back a Dolby Digital encoded DVD Video disc.

If the front speaker size is set to "Small", the Bass redirect setting is fixed to "S.woofer".

Speaker level

(available only when selecting EXPERT)

You can adjust the output level of each speaker.

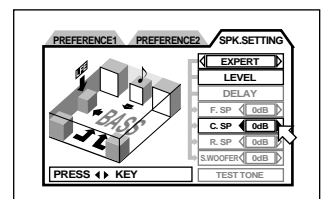

1 Select [LEVEL] using CURSOR ▲/▼, then press ENTER.

The color of "LEVEL" changes.

2 Select the desired speaker(s) to be set using CURSOR ▲/▼.

- **F.SP:** front speakers. the level is fixed to 0dB.
- **C.SP:** center speaker
- **R.SP:** rear speakers
- **S.WOOFER:** sub-woofer

The setting range is between -6dB and +6dB in 1dB steps.

3 Set the level using CURSOR ◀/▶.



- For the speaker(s) whose size is set to “None”, the Speaker level and Delay cannot be set (“—” appears in the setting field).
- However, when playing back a Dolby Digital disc, LFE signal is output from SUBWOOFER output even if S. WOOFER shows “—”, allowing to activate a sub-woofer connected. In such case, adjust the output level using the level control on the sub-woofer.

Delay (available only when selecting EXPERT)

You can adjust the delay time of each speakers.

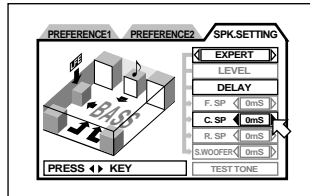

1 Select [DELAY] using CURSOR ▲/▼, then press ENTER.

The color of “DELAY” changes.

2 Select the desired speaker(s) to be set using CURSOR ▲/▼.

- **F.SP:** front speakers. the delay is fixed to 0 ms.
- **C.SP:** center speaker (selectable from 0 to -5 mS in 1 mS units)
- **R.SP:** rear speakers (selectable from 0 mS, -5mS, -10 mS, and -15 mS)

3 Set the delay time using CURSOR ◀/▶.

2 Select the desired speaker(s) using CURSOR ▲/▼.

- **F.SP:** front speakers
- **C.SP:** center speaker
- **R.SP:** rear speakers

After selecting the Test tone, if you do not move the cursor, the test tone is output from each speaker one by one.

In Test tone mode, if you move down from “R.SP” position, the test tone continues to output from the rear speakers as long as is any position other than “F.SP” and “C.SP”. Similarly, if you move up from “F.SP” position, the test tone continues to output from the front speakers as long as is any position other than “C.SP” and “R.SP”.

3 Set the level using CURSOR ◀/▶ again, if necessary.



- In Test tone mode, you hear pink noise, which includes all frequencies in the audible range, from the speakers. This is not a malfunction.
- The test tone is not output from the SUBWOOFER output.

NOTE

• **To exit the test tone mode**

Move to [TEST TONE] in the on-screen display and press ENTER until [TEST TONE] returns to its original color.



Delay of S.WOOFER cannot be set.

NOTE

• **To exit the speaker level (or delay) setting mode**

Move to [LEVEL] (or [DELAY]) in the on-screen display and press ENTER until [LEVEL] (or [DELAY]) returns to its original color.

Test tone (available only while setting LEVEL or DELAY)

You can check the level setting by monitoring the test tone.

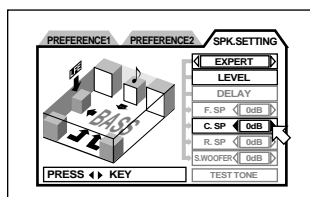

1 Select [TEST TONE] using CURSOR ▲/▼, then press ENTER.

The color of “TEST TONE” changes.

Limiting playback by children

This function restricts playback of DVD Video discs which contain violent (and other) scenes according to the level set by the user. For example, if a movie which includes violent scenes supports the parental lock feature, such scenes which you do not want to let children view can be cut or replaced with other scenes.

To set Parental Lock for the first time [PARENTAL LOCK]

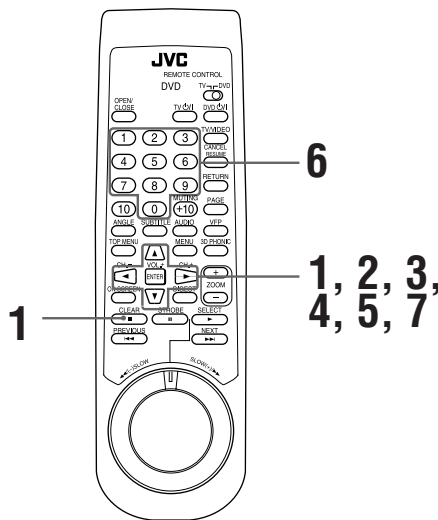

■ While a disc is stopped or no disc is inserted

1 Press **■** and **ENTER** on the remote control unit simultaneously while stopped.

The Parental Lock on-screen display appears on the TV screen.

points [Country Code].

2 While points [Country Code], use **CURSOR** to select the country code.

The country code whose standards were applied to rate the DVD Video disc should be selected.

See "Appendix B: Country code list for parental lock."

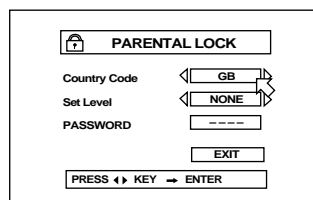

3 Press **ENTER**.

moves to [Set Level].

4 While points [Set Level], use **CURSOR** to select the parental lock level.

Each time you press **CURSOR** , the parental level changes as follows:

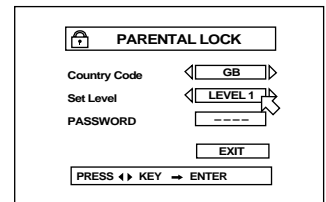
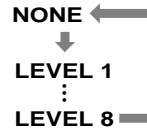

"LEVEL 1" is the strictest level. "NONE" means no restriction. Discs rated higher than the level you selected are restricted.

5 Press **ENTER**.

moves to [PASSWORD].

6 Enter your 4-digit password using the numeric buttons (0 to 9).

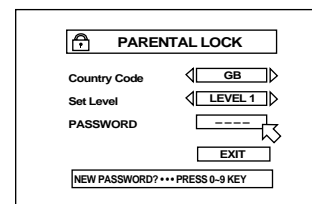

7 Press **ENTER**.

The parental level and password are set.

moves to [EXIT].

Pressing **ENTER** again returns to the opening display.



If you enter an undesired password in step 6 above, reenter the password before pressing **ENTER**.

To change the settings [PARENTAL LOCK]

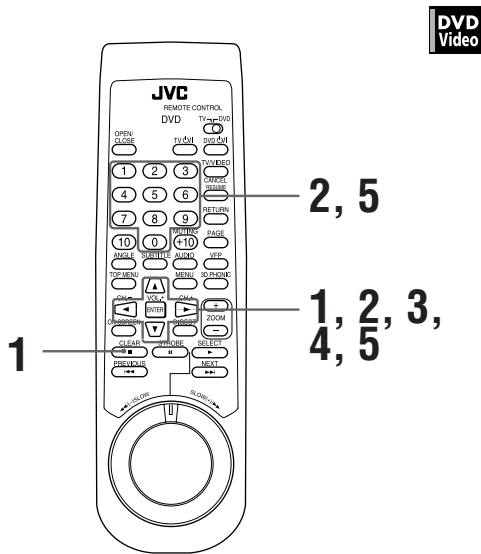

DVD Video

You can change the Parental lock settings (Country code and Set level, as well as your password) later.

■ While a disc is stopped or no disc is inserted

1 Press ENTER while holding down ■.

The Parental Lock on-screen display appears on the TV screen.

↔ points [PASSWORD].

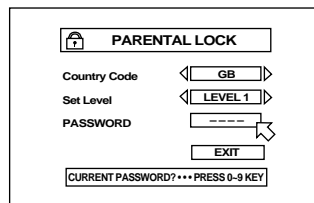

2 Enter your current 4-digit password using the numeric buttons (0 to 9) and press ENTER.

↔ moves to [Country Code] if you enter the correct password.

If you enter the wrong password, "WRONG! RETRY....." appears on the TV screen, and you cannot go to the next step.

3 To change the country code, use CURSOR ▲/▼ to select the desired country code and press ENTER.

↔ moves to [Set Level].

When you change the country code, you must select the parental level.

4 To change the set level, use CURSOR ▲/▼ to select the desired level while ↔ points [Set Level], and then press ENTER.

↔ moves to [PASSWORD].

5 Enter the password using the numeric buttons (0 to 9) and press ENTER.

↔ moves to [EXIT].

The password entered in the above step becomes the new password. If you do not change the password, enter the same password as in the step 2.

Even if you want to change only the country code and/or parental level, do not forget to enter the password after changing the country code and/or parental level. Otherwise, the new country code and/or parental level will not become effective.

Pressing ENTER again returns to the opening display.

NOTES

- When you enter the wrong password more than 3 times in step 2 above, ↔ moves to [EXIT] automatically and CURSOR ▲/▼ does not work.
- If you forget your password in step 2 Enter "8888."

To temporarily release the Parental lock [PARENTAL LOCK]

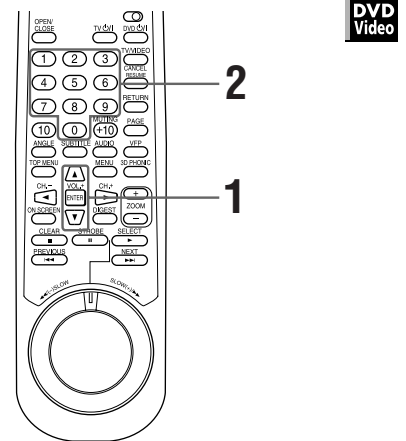

DVD Video

When you set the parental level strictly, some discs may not be played back at all. When you insert such a disc and try to play it, the following Parental Lock on-screen display appears on the TV screen, asking whether you want the parental lock to be temporarily released or not.

1 Use the CURSOR ▲/▼ to move ↔ to [YES], then press ENTER.

↔ moves to [PASSWORD].

When selecting [NO], press OPEN/CLOSE to remove the disc.

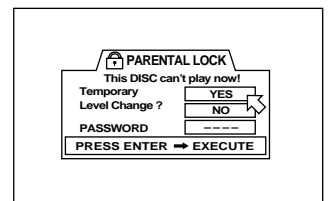

2 Enter your 4-digit password using the numeric buttons (0 to 9) and Press ENTER.

The Parental lock is released, and the unit starts playback.

If you enter the wrong password, "WRONG! RETRY..." appears on the TV screen.

NOTE

- When you enter the wrong password more than 3 times in step 2 above, ↔ moves to [NO] automatically and you have to remove the disc.

Care and handling of discs

How to handle discs

When handling a disc, do not touch the surface of the disc. Since discs are made of plastic, they are easily damaged. If a disc gets dirty, dusty, scratched or warped, the images and sound will not be picked up correctly, and such a disc may cause the player to malfunction.

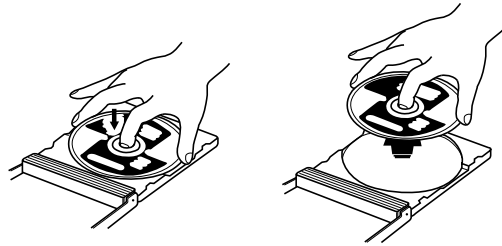

Label side

Do not damage the label side, stick paper to or use any adhesive on its surface.

Storage

Make sure that discs are kept in their cases. If discs are piled on top of one another without their protective cases, they can be damaged. Do not put discs in a location where they may be exposed to direct sunlight, or in a place where the humidity or temperature is high. Avoid leaving discs in your car!

Maintenance of discs

If there are fingerprints or other dirt adhering to a disc, wipe with a soft dry cloth, moving from the center outwards. If a disc is difficult to clean, wipe with a cloth moistened with water. Never use record cleaners, petrol, alcohol or any anti-static agents.

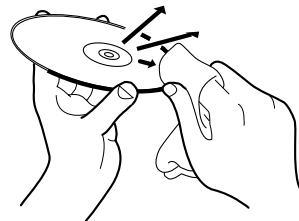

CAUTION

Sometimes during play noise or images may be garbled. This is sometimes due to the disc. (It may not be up to industry standards.)

These symptoms are caused by the discs, not by the malfunction of the unit.

Troubleshooting

What appears to be a malfunction may not always be serious. Please go through the following list before requesting service.

Symptom	Possible cause	Remedy
Power does not come on.	Power plug is not inserted securely.	Plug in securely.
Remote control does not work.	Too far from the unit.	Move closer to the unit.
	The tip of the remote unit is not pointed in the right direction.	Point the infrared light-emitting window toward the remote sensor on the front panel.
	Batteries are exhausted.	Replace the batteries with new ones.
	Battery polarity is incorrect.	Take out the batteries and insert them again in the correct direction.
The TV/VIDEO-CANCEL, CURSOR or numeric buttons do not work.	The TV-DVD switch is not correctly set.	To control the unit, set the TV-DVD switch to "DVD". To control your TV, set the TV-DVD switch to "TV".
No picture is displayed on the monitor.	Connection of video cable is incorrect.	Connect the cable correctly.
	Input selection of TV is incorrect.	Select correctly.
	Disc is not playable.	Use a playable disc. (See page 12.)
	The video signal selectors are not correctly set (if you set the video signal to "RGB", no signal is output from the VIDEO and S-VIDEO jacks).	Set the video signal selectors correctly.
Picture is noisy or blurred.	The unit is connected to a VCR directly and the copyguard function is activated.	Connect the unit so that the picture signal flows directly to the TV.
No audio is reproduced.	Connection is incorrect.	Check the connections.
	Input selection of amplifier is incorrect.	Select correctly.
No audio is reproduced when playing back a DVD disc recorded with high-sampling (88.2-kHz or more), linear PCM audio.	The audio signal derives from the unit's DIGITAL AUDIO OUT.	Use the ANALOG AUDIO OUT when playing back such discs.
Sound is distorted or noise is generated.	Disc is dirty.	Wipe the disc surface.
Picture is garbled.	The screen saver mode is set to "MODE 1", and the screen saver function is activated.	Set the screen saver mode to the other mode.
Picture does not fit the television screen.	"MONITOR TYPE" is not correctly set.	Select monitor type correctly. (See page 41.)
	Television is not correctly set.	Set the television correctly.
Operation is not possible.	Microcomputer malfunctions due to lightning or static electricity.	Turn off the power and unplug the power cord, then connect the power cord again.
	Moisture condensation occurs by a sudden change of temperature or humidity.	Turn off the power, then turn it on a few hours later.

Specifications

General

Readable discs: DVD Audio, DVD Video, Audio CD, Video CD
 Video format: PAL

Other

Power requirements: AC 230 V ~ , 50 Hz
 Power consumption: 22 W (POWER ON), 1.5 W (STANDBY mode)
 Mass: 3.7 kg (8.2 lbs)
 Dimensions (W x H x D): 435 mm x 112.5 mm x 334 mm
 (17-3/16 inch x 4-7/16 inch x 13-3/16 inch)

Video output

VIDEO OUT (pin jack): 1.0 V_{p-p} (75Ω)
 S-VIDEO OUT (S jack): Y Output: 1.0 V_{p-p} (75Ω)
 C Output: 300 mV_{p-p} (75Ω)
 RGB OUT (AV connector): 0 - 700 mV (75Ω)
 Horizontal resolution: 500 Lines
 Signal to noise ratio: 65 dB

Audio output

ANALOG OUT (pin jack): 2.0 V_{rms} (10kΩ)
 DIGITAL OUT (optical): - 21 dBm to -15 dBm (Peak)
 (coaxial): 0.5 V_{p-p} (75Ω)

Audio characteristics

Frequency response: CD (at 44.1 kHz sampling frequency) : 2 Hz to 20 kHz
 DVD (at 48 kHz sampling frequency) : 2 Hz to 22 kHz
 (2 Hz to 20 kHz for DTS and Dolby Digital bitstream signals)
 DVD (at 96/88.2 kHz sampling frequency) : 2 Hz to 44 kHz
 DVD (at 192/176.4 kHz sampling frequency) : 2 Hz to 88 kHz
 Dynamic range: 16 bit: more than 100 dB
 20 bit: more than 110 dB
 24 bit: more than 110 dB
 Wow and flutter: Unmeasurable (less than ± 0.002%)
 Total harmonic distortion: 16 bit : less than 0.0018%
 20/24 bit : less than 0.0012%

* Specifications and appearance subject to change without prior notice.

Appendix A: Table of languages and their abbreviations

When you select the subtitle language or sound, the languages shown below are displayed as abbreviations. To select the desired language, select the abbreviation corresponding the language you want to.

AA	Afar
AB	Abkhazian
AF	Afrikaans
AM	Ameharic
AR	Arabic
AS	Assamese
AY	Aymara
AZ	Azerbaijani
BA	Bashkir
BE	Byelorussian
BG	Bulgarian
BH	Bihari
BI	Bislama
BN	Bengali, Bangla
BO	Tibetan
BR	Breton
CA	Catalan
CO	Corsican
CS	Czech
CY	Welsh
DA	Danish
DZ	Bhutani
EL	Greek
EO	Esperanto
ET	Estonian
EU	Basque
FA	Persian
FI	Finnish
FJ	Fiji
FO	Faroese
FY	Frisian
GA	Irish
GD	Scots Gaelic
GL	Galician
GN	Guarani
GU	Gujarati
HA	Hausa
HI	Hindi
HR	Croatian
HU	Hungarian
HY	Armenian
IA	Interlingua
IE	Interlingue

IK	Inupiak
IN	Indonesian
IS	Icelandic
IW	Hebrew
JI	Yiddish
JW	Javanese
KA	Georgian
KK	Kazakh
KL	Greenlandic
KM	Cambodian
KN	Kannada
KO	Korean (KOR)
KS	Kashmiri
KU	Kurdish
KY	Kirghiz
LA	Latin
LN	Lingala
LO	Laothian
LT	Lithuanian
LV	Latvian, Lettish
MG	Malagasy
MI	Maori
MK	Macedonian
ML	Malayalam
MN	Mongolian
MO	Moldavian
MR	Marathi
MS	Malay (MAY)
MT	Maltese
MY	Burmese
NA	Nauru
NE	Nepali
NL	Dutch
NO	Norwegian
OC	Occitan
OM	(Afan) Oromo
OR	Oriya
PA	Panjabi
PL	Polish
PS	Pashto, Pushto
PT	Portuguese
QU	Quechua
RM	Rhaeto-Romance

RN	Kirundi
RO	Rumanian
RU	Russian
RW	Kinyarwanda
SA	Sanskrit
SD	Sindhi
SG	Sangho
SH	Serbo-Croatian
SI	Singhalese
SK	Slovak
SL	Slovenian
SM	Samoan
SN	Shona
SO	Somali
SQ	Albanian
SR	Serbian
SS	Siswati
ST	Sesotho
SU	Sundanese
SV	Swedish
SW	Swahili
TA	Tamil
TE	Telugu
TG	Tajik
TH	Thai
TI	Tigrinya
TK	Turkmen
TL	Tagalog
TN	Setswana
TO	Tonga
TR	Turkish
TS	Tsonga
TT	Tatar
TW	Twi
UK	Ukrainian
UR	Urdu
UZ	Uzbek
VI	Vietnamese
VO	Volapuk
WO	Wolof
XH	Xhosa
YO	Yoruba
ZU	Zulu

Appendix B: Country code list for parental lock

This list is used for the parental Lock operation. For details, see page 46.

AD	Andorra
AE	United Arab Emirates
AF	Afghanistan
AG	Antigua and Barbuda
AI	Anguilla
AL	Albania
AM	Armenia
AN	Netherlands Antilles
AO	Angola
AQ	Antarctica
AR	Argentina
AS	American Samoa
AT	Austria
AU	Australia
AW	Aruba
AZ	Azerbaijan
BA	Bosnia and Herzegovina
BB	Barbados
BD	Bangladesh
BE	Belgium
BF	Burkina Faso
BG	Bulgaria
BH	Bahrain
BI	Burundi
BJ	Benin
BM	Bermuda
BN	Brunei Darussalam
BO	Bolivia
BR	Brazil
BS	Bahamas
BT	Bhutan
BV	Bouvet Island
BW	Botswana
BY	Belarus
BZ	Belize
CA	Canada
CC	Cocos (Keeling) Islands
CF	Central African Republic
CG	Congo
CH	Switzerland
CI	Côte d'Ivoire
CK	Cook Islands
CL	Chile
CM	Cameroon
CN	China
CO	Colombia
CR	Costa Rica
CU	Cuba
CV	Cape Verde
CX	Christmas Island
CY	Cyprus
CZ	Czech Republic
DE	Germany
DJ	Djibouti
DK	Denmark
DM	Dominica
DO	Dominican Republic
DZ	Algeria
EC	Ecuador
EE	Estonia
EG	Egypt
EH	Western Sahara
ER	Eritrea

ES	Spain
ET	Ethiopia
FI	Finland
FJ	Fiji
FK	Falkland Islands (Malvinas)
FM	Micronesia (Federated States of)
FO	Faroe Islands
FR	France
FX	France, Metropolitan
GA	Gabon
GB	United Kingdom
GD	Grenada
GE	Georgia
GF	French Guiana
GH	Ghana
GI	Gibraltar
GL	Greenland
GM	Gambia
GN	Guinea
GP	Guadeloupe
GQ	Equatorial Guinea
GR	Greece
GS	South Georgia and the South Sandwich Islands
GT	Guatemala
GU	Guam
GW	Guinea-Bissau
GY	Guyana
HK	Hong Kong
HM	Heard Island and McDonald Islands
HN	Honduras
HR	Croatia
HT	Haiti
HU	Hungary
ID	Indonesia
IE	Ireland
IL	Israel
IN	India
IO	British Indian Ocean Territory
IQ	Iraq
IR	Iran (Islamic Republic of)
IS	Iceland
IT	Italy
JM	Jamaica
JO	Jordan
JP	Japan
KE	Kenya
KG	Kyrgyzstan
KH	Cambodia
KI	Kiribati
KM	Comoros
KN	Saint Kitts and Nevis
KP	Korea, Democratic People's Republic of
KR	Korea, Republic of
KW	Kuwait
KY	Cayman Islands
KZ	Kazakhstan
LA	Lao People's Democratic Republic

LB	Lebanon
LC	Saint Lucia
LI	Liechtenstein
LK	Sri Lanka
LR	Liberia
LS	Lesotho
LT	Lithuania
LU	Luxembourg
LV	Latvia
LY	Libyan Arab Jamahiriya
MA	Morocco
MC	Monaco
MD	Moldova, Republic of
MG	Madagascar
MH	Marshall Islands
ML	Mali
MM	Myanmar
MN	Mongolia
MO	Macau
MP	Northern Mariana Islands
MQ	Martinique
MR	Mauritania
MS	Montserrat
MT	Malta
MU	Mauritius
MV	Maldives
MW	Malawi
MX	Mexico
MY	Malaysia
MZ	Mozambique
NA	Namibia
NC	New Caledonia
NE	Niger
NF	Norfolk Island
NG	Nigeria
NI	Nicaragua
NL	Netherlands
NO	Norway
NP	Nepal
NR	Nauru
NU	Niue
NZ	New Zealand
OM	Oman
PA	Panama
PE	Peru
PF	French Polynesia
PG	Papua New Guinea
PH	Philippines
PK	Pakistan
PL	Poland
PM	Saint Pierre and Miquelon
PN	Pitcairn
PR	Puerto Rico
PT	Portugal
PW	Palau
PY	Paraguay
QA	Qatar
RE	Réunion
RO	Romania
RU	Russian Federation
RW	Rwanda

SA	Saudi Arabia
SB	Solomon Islands
SC	Seychelles
SD	Sudan
SE	Sweden
SG	Singapore
SH	Saint Helena
SI	Slovenia
SJ	Svalbard and Jan Mayen
SK	Slovakia
SL	Sierra Leone
SM	San Marino
SN	Senegal
SO	Somalia
SR	Suriname
ST	Sao Tome and Principe
SV	El Salvador
SY	Syrian Arab Republic
SZ	Swaziland
TC	Turks and Caicos Islands
TD	Chad
TF	French Southern Territories
TG	Togo
TH	Thailand
TJ	Tajikistan
TK	Tokelau
TM	Turkmenistan
TN	Tunisia
TO	Tonga
TP	East Timor
TR	Turkey
TT	Trinidad and Tobago
TV	Tuvalu
TW	Taiwan, Province of China
TZ	Tanzania, United Republic of
UA	Ukraine
UG	Uganda
UM	United States Minor Outlying Islands
US	United States
UY	Uruguay
UZ	Uzbekistan
VA	Vatican City State (Holy See)
VC	Saint Vincent and the Grenadines
VE	Venezuela
VG	Virgin Islands (British)
VI	Virgin Islands (U.S.)
VN	Vietnam
VU	Vanuatu
WF	Wallis and Futuna Islands
WS	Samoa
YE	Yemen
YT	Mayotte
YU	Yugoslavia
ZA	South Africa
ZM	Zambia
ZR	Zaire
ZW	Zimbabwe



SAFETY INSTRUCTIONS

“SOME DOS AND DON'TS ON THE SAFE USE OF EQUIPMENT”

This equipment has been designed and manufactured to meet international safety standards but, like any electrical equipment, care must be taken if you are to obtain the best results and safety is to be assured.

Do read the operating instructions before you attempt to use the equipment.

Do ensure that all electrical connections (including the mains plug, extension leads and interconnections between pieces of equipment) are properly made and in accordance with the manufacturer's instructions. Switch off and withdraw the mains plug when making or changing connections.

Do consult your dealer if you are ever in doubt about the installation, operation or safety of your equipment.

Do be careful with glass panels or doors on equipment.

DON'T continue to operate the equipment if you are in any doubt about it working normally, or if it is damaged in any way— switch off, withdraw the mains plug and consult your dealer.

DON'T remove any fixed cover as this may expose dangerous voltages.

DON'T leave equipment switched on when it is unattended unless it is specifically stated that it is designed for unattended operation or has a standby mode.
Switch off using the switch on the equipment and make sure that your family know how to do this.

Special arrangements may need to be made for infirm or handicapped people.

DON'T use equipment such as personal stereos or radios so that you are distracted from the requirements of traffic safety. It is illegal to watch television whilst driving.

DON'T listen to headphones at high volume as such use can permanently damage your hearing.

DON'T obstruct the ventilation of the equipment, for example with curtains or soft furnishings.

Overheating will cause damage and shorten the life of the equipment.

DON'T use makeshift stands and NEVER fix legs with wood screws — to ensure complete safety always fit the manufacturer's approved stand or legs with the fixings provided according to the instructions.

DON'T allow electrical equipment to be exposed to rain or moisture.

ABOVE ALL

- NEVER let anyone, especially children, push anything into holes, slots or any other opening in the case -this could result in a fatal electrical shock.;
- NEVER guess or take chances with electrical equipment of any kind -it is better to be safe than sorry!

JVC
VICTOR COMPANY OF JAPAN, LIMITED